

SPLIT SYSTEM**Air Conditioners**

MODELS**Ceiling mounted cassette type (Round flow model)****FCQ71KVEA****FCQ100KVEA****FCQ125KVEA****FCQ140KVEA****FCQN71KVEA****FCQN100KVEA****FCQN125KVEA****FCQN140KVEA**

Thank you for purchasing this Daikin air conditioner.

Carefully read this operation manual before using the air conditioner. It will tell you how to use the unit properly and help you if any trouble occurs. This manual explains about the indoor unit only. Use it along with the operation manual for the outdoor unit. After reading the manual, file it away for future reference.

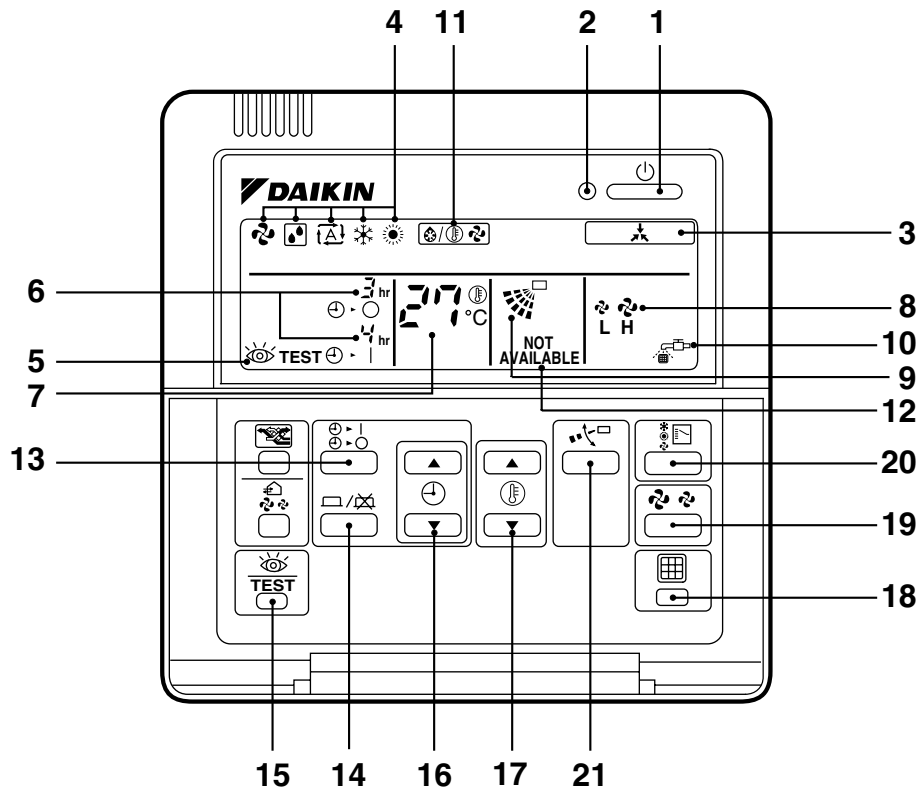

1

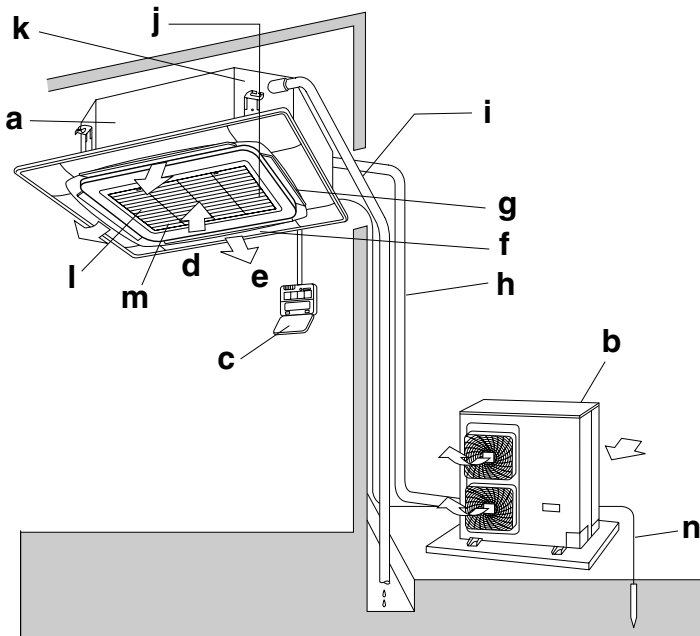

2

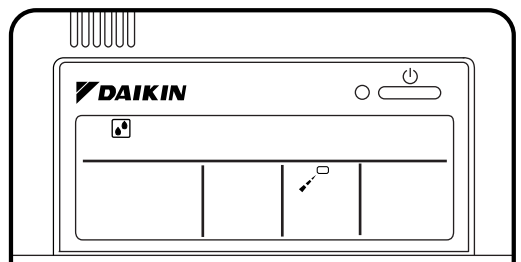

3

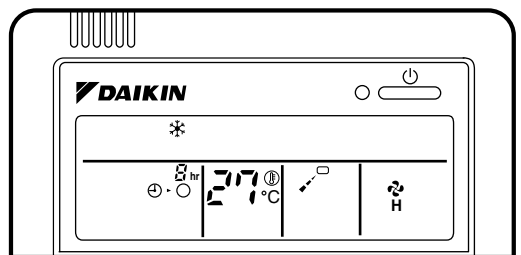

4

CONTENTS

ILLUSTRATIONS.....	3
WHAT TO DO BEFORE OPERATION.....	4
SAFETY CONSIDERATIONS	4
OPERATION RANGE.....	6
INSTALLATION SITE	6
NAME AND FUNCTION OF EACH SWITCH AND DISPLAY ON THE REMOTE CONTROLLER	6
OPERATION PROCEDURE.....	7
OPTIMUM OPERATION.....	9
MAINTENANCE (FOR SERVICE PERSONNEL).....	9
NOT MALFUNCTION OF THE AIR CONDITIONER.....	11
TROUBLE SHOOTING.....	12

WHAT TO DO BEFORE OPERATION

This operation manual is for the following system with standard control. Before initiating operation, contact your dealer for the operation that corresponds to your system.

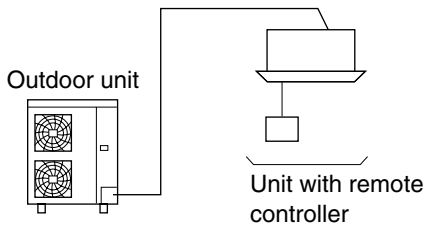

NOTE

- If the unit you purchased is controlled by a wireless remote controller, also refer to the wireless remote controller's operation manual.

If your installation has a customized control system, ask your dealer for the operation that corresponds to your system.

TWO REMOTE CONTROLLERS CONTROL SYSTEM

Confirm the following if your unit is the following control system type.

- Two remote controllers control system**
Two remote controllers control one indoor unit.
The unit is individually operated.

NOTE

- Contact your dealer in case of two remote controllers control system.

Names and functions of parts

Refer to figure 2 on page 3

a	Indoor unit
b	Outdoor unit
c	Remote controller Depending on the system configuration, the remote controller is not provided.
d	Inlet air
e	Discharge air
f	Air outlet
g	Air flow flap (at air outlet)
h	Refrigerant piping, connection electric wire
i	Drain pipe
j	Model name (model name plate) (Inside of suction grille)
k	Drain pumping out device(built-in) Condensate removed from the room during cooling.
l	Air filter (suction grille)

m	Suction grille
n	Ground wire The line passes electricity from the inside unit to the ground to prevent accidental electrical shock.

SAFETY CONSIDERATIONS

To gain full advantage of the air conditioner's functions and to avoid malfunction due to mishandling, we recommend that you read this instruction manual carefully before use. This air conditioner is classified under "appliances not accessible to the general public".

- The precautions described herein are classified as **WARNING and CAUTION. They both contain important information regarding safety. Be sure to observe all precautions without fail.**

WARNING Failure to follow these instructions properly may result in personal injury or loss of life.

CAUTION Failure to observe these instructions properly may result in property damage or personal injury, which may be serious depending on the circumstances.

- After reading, keep this manual in a convenient place so that you can refer to it whenever necessary. If the equipment is transferred to a new user, be sure also to hand over the manual.

WARNING

Be aware that prolonged, direct exposure to cool or warm air from the air conditioner, or to air that is too cool or too warm can be harmful to your physical condition and health.

When the air conditioner is malfunctioning (giving off a burning odour, etc.) turn off power to the unit and contact your local dealer.

Continued operation under such circumstances may result in a failure, electric shocks or fire hazards.

Consult your local dealer about installation work.

Doing the work yourself may result in water leakage, electric shocks or fire hazards.

Consult your local dealer regarding modification, repair and maintenance of the air conditioner.

Improper workmanship may result in water leakage, electric shocks or fire hazards.

Do not place objects, including rods, your fingers, etc., in the air inlet or outlet.

Injury may result due to contact with the air conditioner's highspeed fan blades.

Consult your local dealer regarding what to do in case of refrigerant leakage.

When the air conditioner is to be installed in a small room, it is necessary to take proper measures so that the amount of any leaked refrigerant does not exceed the concentration limit in the event of a leakage. Otherwise, this may lead to an accident due to oxygen depletion.

Contact professional personnel about attachment of accessories and be sure to use only accessories specified by the manufacturer.

If a defect results from your own workmanship, it may result in water leaks, electric shock or fire.

Consult your local dealer regarding relocation and reinstallation of the air conditioner.

Improper installation work may result in leakage, electric shocks or fire hazards.

Beware of fire in case of refrigerant leakage.

If the air conditioner is not operating correctly, i.e. not generating cool or warm air, refrigerant leakage could be the cause. Consult your dealer for assistance. The refrigerant within the air conditioner is safe and normally does not leak. However, in the event of a leakage, contact with a naked burner, heater or cooker may result in generation of noxious gas. Do not longer use the air conditioner until a qualified service person confirms that the leakage has been repaired.

Be sure to use fuses with the correct ampere reading.

Do not use improper fuses, copper or other wires as a substitute, as this may result in electric shock, fire, injury or damage to the unit.

Be sure to earth the unit.

Do not earth the unit to a utility pipe, lightning conductor or telephone earth lead. Imperfect earthing may result in electric shocks.

Be sure to install an earth leakage breaker.

Failure to install an earth leakage breaker may result in electric shocks or fire.

Consult the dealer if the air conditioner submerges owing to a natural disaster, such as a flood or typhoon.

Do not operate the air conditioner in that case, or otherwise a malfunction, electric shock, or fire may result.

Do not start or stop operating the air conditioner with the power supply breaker turned ON or OFF.

Otherwise, fire or water leakage may result. Furthermore, the fan will rotate abruptly if power failure compensation is enabled, which may result in injury.

Do not use the product in the atmosphere contaminated with oil vapor, such as cooking oil or machine oil vapor.

Oil vapor may cause crack damage, electric shocks, or fire.

Do not use the product in places with excessive oily smoke, such as cooking rooms, or in places with flammable gas, corrosive gas, or metal dust.

Using the product in such places may cause fire or product failures.

Do not use flammable materials (e.g., hairspray or insecticide) near the product.

Do not clean the product with organic solvents such as paint thinner.

The use of organic solvents may cause crack damage to the product, electric shocks, or fire.

Be sure to use a dedicated power supply for the air conditioner.

The use of any other power supply may cause heat generation, fire, or product failures.

⚠ CAUTION

Do not use the air conditioner for purposes other than those for which it is intended.

Do not use the air conditioner for cooling precision instruments, food, plants, animals or works of art as this may adversely affect the performance, quality and/or longevity of the object concerned.

Do not remove the outdoor unit's fan guard.

The guard protects against the unit's high speed fan, which may cause injury.

To avoid oxygen depletion, ensure that the room is adequately ventilated if equipment such as a burner is used together with the air conditioner.

After prolonged use, check the unit stand and its mounts for damage.

If left in a damaged condition, the unit may fall and cause injury.

Do not put flammable containers, such as spray cans, within 1 m from the blow-off mouth.

The containers may explode because the warm air output of the indoor or outdoor unit will affect them.

Before cleaning, be sure to stop unit operation, turn the breaker off or remove the power cord.

Otherwise, an electric shock and injury may result.

To avoid electric shocks, do not operate with wet hands.

Do not place objects that are susceptible to moisture directly beneath the indoor or outdoor units.

Under certain conditions, condensation on the main unit or refrigerant pipes, air filter dirt or drain blockage may cause dripping, resulting in fouling or failure of the object concerned.

Do not place appliances that produce naked flames in places exposed to the air flow from the unit as this may impair combustion of the burner.

Do not place heaters directly below the unit, as resulting heat can cause deformation.

Do not allow a child to mount on the outdoor unit or avoid placing any object on it.

Falling or tumbling may result in injury.

Do not let children play on or around the outdoor unit.

If they touch the unit carelessly, injury may be caused.

Be sure that children, plants or animals are not exposed directly to airflow from the unit, as adverse effects may ensue.

Do not wash the air conditioner with water, as this may result in electric shocks or fire.

Do not install the air conditioner at any place where there is a danger of flammable gas leakage.

In the event of a gas leakage, build-up of gas near the air conditioner may result in fire hazards.

Arrange the drain hose to ensure smooth drainage.

Imperfect drainage may cause wetting.

The appliance is not intended for use by unattended young children or infirm persons.

Impairment of bodily functions and harm to health may result.

Children should be supervised to ensure that they do not play with the unit or its remote controller.

Accidental operation by a child may result in impairment of bodily functions and harm health.

Consult your dealer regarding cleaning the inside of the air conditioner.

Improper cleaning may cause breakage of plastic parts, water leakage and other damage as well as electric shocks.

To avoid injury, do not touch the air inlet or aluminium fins of the unit.

Do not place objects in direct proximity of the outdoor unit and do not let leaves and other debris accumulate around the unit.

Leaves are a hotbed for small animals which can enter the unit. Once in the unit, such animals can cause malfunctions, smoke or fire when making contact with electrical parts.

Do not block air inlets nor outlets.

Impaired air flow may result in insufficient performance or trouble.

Never touch the internal parts of the controller.

Do not remove the front panel. Touching certain internal parts will cause electric shocks and damage to the unit. Please consult your dealer about checking and adjustment of internal parts.

Do not leave the remote controller wherever there is a risk of wetting.

If water gets into the remote controller there is a risk of electrical leakage and damage to electronic components.

Take care of scaffolding and exercise caution when working high above ground level.

OPERATION RANGE

If the temperature or the humidity is beyond the following conditions, safety devices may work and the air conditioner may not operate, or sometimes, water may drop from the indoor unit.

COOLING

OUTDOOR UNIT	INDOOR		OUTDOOR TEMPERATURE		
	TEMPERATURE	HUMIDITY			
RZQ 71 100 125 160	D B	21 to 32	80% or below	D B	-5 to 46
RQ 71 100 125 160					

HEATING

For FCQ71 · 100 · 125 · 140KVEA

OUTDOOR UNIT	INDOOR TEMPERATURE		OUTDOOR TEMPERATURE	
RZQ 71 100 125 160	D B	15 to 27	D B	-15 to 21
			W B	-15 to 16

For FCQN71 · 100 · 125 · 140KVEA

OUTDOOR UNIT	INDOOR TEMPERATURE		OUTDOOR TEMPERATURE	
RQ 71 100 125 160	D B	15 to 27	D B	-10 to 21
			W B	-10 to 16

D B: Dry bulb temperature

WB: Wet bulb temperature

The setting temperature range of the remote controller is 16°C to 32°C.

■ Tips for saving energy

- Be careful not to cool (heat) the room too much. Keeping the temperature setting at a moderate level helps save energy.
- Cover windows with a blind or a curtain. Blocking sunlight and air from outdoors increases the cooling (heating) effect.

Recommended temperature setting	
For cooling	26 to 28 °C
For heating	20 to 24 °C

INSTALLATION SITE

Regarding places for installation

- **Is the air conditioner installed at a well-ventilated place where there are no obstacles around?**
- **Do not use the air conditioner in the following places.**
 - a. Filled with much mineral oil such as cutting oil
 - b. Where there is much salt such as a beach area
 - c. Where sulfured gas exists such as a hot-spring resort
 - d. Where there are considerable voltage fluctuations such as a factory or plant
 - e. Vehicles and vessels
 - f. Where there is much spray of oil and vapor such as a cookery, etc.
 - g. Where there are machines generating electromagnetic waves
 - h. Filled with acid and/or alkaline steam or vapor
- **Is a snow protection measure taken?**
For details, consult your dealer.

Regarding wiring

- **All wiring must be performed by an authorized electrician.**
To do wiring, ask your dealer. Never do it by yourself.
- **Make sure that a separate power supply circuit is provided for this air conditioner and that all electrical work is carried out by qualified personnel according to local laws and regulations.**

Pay attention to running noises, too

- **Are the following places selected?**
 - a. A place that can sufficiently withstand the weight of the air conditioner with less running noises and vibrations.
 - b. A place where the hot wind discharged from the air outlet of the outdoor unit and the running noises.
- **Are you sure that there are no obstacles near the air outlet of the outdoor unit?**
Such obstacles may result in declined performance and increased running noises.
- **If abnormal noises occur in use, consult your dealer.**

Regarding drainage of drain pipe









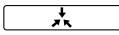
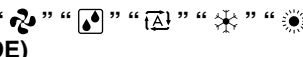

- **Is the drain pipe executed to perform complete drainage?**
If proper drainage is not carried out from the outdoor drain pipes during air-conditioning operation, chances are that dust and dirt are clogged in the pipe. This may result in a water leakage from the indoor unit. Under such circumstances, stop the operation of the air conditioner, and then consult your dealer or our service station.

NAME AND FUNCTION OF EACH SWITCH AND DISPLAY ON THE REMOTE CONTROLLER

■ Refer to figure 1 on page 3 ■

The illustrations in this operating manual correspond to the remote control format BRC1C type.

1	ON/OFF button
	Press the button and the system will start. Press the button again and the system will stop.
2	OPERATION lamp (RED)
	The lamp lights up during operation.

3	DISPLAY “” (UNDER CENTRALIZED CONTROL)
	When this display shows, the system in UNDER CENTRALIZED CONTROL. (This is not a standard specification)
4	DISPLAY “” (OPERATION MODE)
	This display shows the current OPERATION MODE. Only for cooling models on which “  ” is not displayed.
5	DISPLAY “ TEST” (INSPECTION/TEST OPERATION)
	When the INSPECTION/TEST OPERATION BUTTON is pressed, the display shows the system mode is in.
6	DISPLAY “” (PROGRAMMED TIME)
	This display shows PROGRAMMED TIME of the system start or stop.
7	DISPLAY “” (SET TEMPERATURE)
	This display shows the set temperature.
8	DISPLAY “” (FAN SPEED)
	The display shows the fan speed: “LOW” or “HIGH”.
9	DISPLAY “” (AIR FLOW FLAP)
	Refer to page 8.
10	DISPLAY “” (TIME TO CLEAN AIR FILTER)
	Refer to page 9.
11	DISPLAY “” (DEFROST/HOT START)
	Refer to page 8. “  ” is not displayed when the unit is in cooling only mode.
12	NON-FUNCTIONING DISPLAY
	If that particular function is not available, pressing the button may display the words “NOT AVAILABLE” for a few seconds.
13	TIMER MODE START/STOP button
	Refer to page 8.
14	TIMER ON/OFF button
	Refer to page 8.
15	INSPECTION/TEST OPERATION button
	This button is used only by qualified service persons for maintenance purposes. Do not use it in normal operation.
16	PROGRAMMING TIME button
	Use this button for programming “START and/or STOP” time.
17	TEMPERATURE SETTING button
	Use this button for SETTING TEMPERATURE of the thermostat.
18	FILTER SIGN RESET button
	Refer to page 10.
19	FAN SPEED CONTROL button
	Press this button to select the fan speed, LOW or HIGH, of your choice.

20	OPERATION MODE SELECTOR button
	Press this button to select OPERATION MODE.
21	AIR FLOW DIRECTION ADJUST button
	Refer to page 8.
NOTE 	
<ul style="list-style-type: none"> For the sake of explanation, all indications are shown on the display in figure 1 on page 3 contrary to actual running situations. 	





OPERATION PROCEDURE

Refer to figure 1 on page 3

- To protect the unit, turn on the main power supply switch 6 hours before operation.
- If the main power supply switch is turned off during operation, operation will restart automatically after the power turns back on again.

COOLING · HEATING · AUTOMATIC · FAN AND PROGRAM DRY Operation

Operate in the following order.

- Press **OPERATION MODE SELECTOR button** several times and select the **OPERATION MODE** of your choice as follows.
 - COOLING Operation “”
 - HEATING Operation “”
 - AUTOMATIC Operation “”
 - In this operation mode, COOL/HEAT changeover is automatically conducted.
 - FAN Operation “”
 - DRY Operation “”
 - The function of this program is to decrease the humidity in your room with the minimum temperature decrease.
 - Micro computer automatically determines TEMPERATURE and FAN SPEED.
 - This system does not go into operation if the room temperature is below 16°C.

Refer to figure 3 on page 3

- Press **ON/OFF button**.
OPERATION lamp lights up and the system starts OPERATION.

ADJUSTMENT

- Press **TEMPERATURE SETTING button** and program the setting temperature.

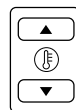

Each time this button is pressed, setting temperature rises 1°C.

Each time this button is pressed, setting temperature lowers 1°C.

NOTE

- Set the temperature within the operation range shown in the table on page 6.
 - The temperature cannot be set in the fan operation.
- Press **FAN SPEED CONTROL button**.
High or Low fan speed can be selected.

NOTE

- In the heating operation, the fan stops during defrosting or at startup. It does not indicate any abnormality.
- Press **AIR FLOW DIRECTION ADJUST button**.
Refer to page 8 for details.

STOPPING THE SYSTEM

6. Press ON/OFF button once again.

- OPERATION lamp goes off, and the system stops OPERATION.
- The fan may keep on running for about 1 minute after the heating operation stops.
(To start the next operation smoothly.)

ATTENTION:

- Do not turn OFF power immediately after the unit stops. Then, wait no less than 5 minutes. Water is leaking or there is something else wrong with the unit.
- When the operation is started again immediately after being stopped, when the operation mode is changed over, or when the TEMPERATURE SETTING button is pressed then returned soon, the air conditioner will start the operation automatically about 5 minutes later (because the air conditioner is controlled so that excessive load is not applied).

— Characteristics of the heating operation —

(1) DEFROST OPERATION

- As the frost on the coil of an outdoor unit increase, heating effect decreases and the system goes into DEFROST OPERATION.
- The indoor unit fan stops and the remote controller displays shows “” (DEFROST/HOT START).
- After 6 to 8 minutes (maximum 10 minutes) of DEFROST OPERATION, the system returns to HEATING OPERATION.

(2) HOT START

- In order to prevent cold air from blowing out of an indoor unit at the start of heating operation, the indoor fan is automatically stopped. The display of the remote controller shows “” (DEFROST/HOT START).

(3) OPERATION START

- For ordinary heating, it will take longer for the room temperature to reach the set temperature than with cooling. We therefore recommend starting the unit ahead of time using the timer operation.

ADJUSTING THE AIR FLOW DIRECTION

- Press the AIR FLOW DIRECTION button to adjust the air flow angle.

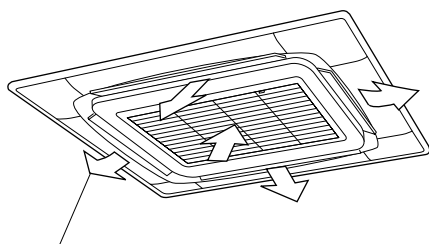

Up and down adjustment

1. Press the AIR FLOW DIRECTION ADJUST button to select the air direction as shown below.

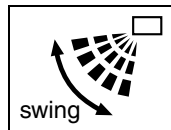

The AIR FLOW FLAP display swings as shown left and the air flow direction continuously varies.
(Automatic swing setting)

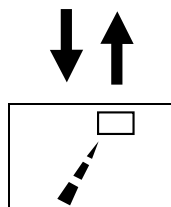

Press AIR FLOW DIRECTION ADJUST button to select the air direction of your choice.

The AIR FLOW FLAP display stops swinging and the air flow direction is fixed.
(Fixed air flow direction setting)

MOVEMENT OF THE AIR FLOW FLAP

For the following conditions, micro computer controls the air flow direction so it may be different from the display.

Operation mode	Cooling	Heating
Operation conditions	<ul style="list-style-type: none"> • When room temperature is lower than the set temperature 	<ul style="list-style-type: none"> • When room temperature is higher than the set temperature • At defrost operation
	<ul style="list-style-type: none"> • When operating continuously at horizontal air flow direction 	

Operation mode include automatic operation.

The air flow direction can be adjusted in either of the following ways.

- Automatic
The air flow flap adjusts its position itself.
- Fixed air flow direction
The air flow direction can be fixed by the user.

<Automatic>

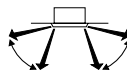

<Fixed air flow direction>







ATTENTION:

- The movable limit of the flap is changeable. Contact your Daikin dealer for details.
- Avoid operating in the horizontal direction “” which may cause dew or dust to settle on ceiling.

PROGRAM TIMER Operation



Operate in the following order.



- The timer is operated by the following two ways.
Programming the stop time ( > ).....
The system stops operating after the time setting has elapsed.
Programming the start time ( > ).....
The system starts operating after the time setting has elapsed.
- The timer can be programmed for a maximum of 72 hours.
- The start and the stop time can simultaneously be programmed.

Refer to figure 4 on page 3

1. Press the TIMER MODE START/STOP button several times and select the mode on the display.

The display flashes.

For setting the timer stop “  >  ”

For setting the timer start “  >  ”

2. Press the PROGRAMMING TIME button and set the time for stopping or starting the system.

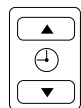

When this button is pressed, the time advances by 1 hour.

When this button is pressed, the time goes backward by 1 hour.

3. Press the TIMER ON/OFF button.

The timer setting procedure ends.

The display “  >  ” or “  >  ” changes from flashing light to a constant light.

NOTE

- When setting the timer Off and On at the same time, repeat the above procedure (from 1 to 3) once again.
- After the timer is programmed, the display shows the remaining time.

- Press the TIMER ON/OFF button once again to cancel programming. The display vanishes.

For example:

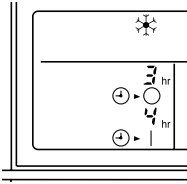

When the timer is programmed to stop the system after 3 hours and start the system after 4 hours, the system will stop after 3 hours and then 1 hour later the system will start.

OPTIMUM OPERATION

Observe the following precautions to ensure the system operates.

- Adjust the room temperature properly for a comfortable environment. Avoid excessive heating or cooling.
- Prevent direct sunlight from entering a room during cooling operation by using curtains or blinds.
- Ventilate the room regularly.
Using the unit for long periods of time requires attentive ventilation of the room.
- Keep doors and windows closed. If the doors and windows remain open, room air will flow out and cause to decrease the effect of cooling and heating.
- Never place objects near the air inlet and the air outlet of the unit. It may cause deterioration in the effect or stop in the operation.
- Turn off the main power supply switch when it is not used for long periods of time. When the main power supply switch is turned on, some watts of electricity is being used even if the system is not operating. Turn off the main power supply switch for saving energy. When reoperating, turn on the main power supply switch 6hours before operation for smooth running (Refer to MAINTENANCE).
- When the display shows “” (TIME TO CLEAN AIR FILTER), ask a qualified service person to clean the filter (Refer to MAINTENANCE).
- Fully use the function of air flow direction adjust.
Cold air gathers on the floor, and warm air gathers in the ceiling.
Set the air flow direction parallel during cooling or dry operation, and set it downwards during heating operation. Do not let the air blow directly to a person.
- It takes time for the room temperature to reach the set temperature.
We recommend starting the operation in advance using timer operation.

MAINTENANCE (FOR SERVICE PERSONNEL)

⚠ WARNING

- Only a qualified person is allowed to perform maintenance without daily maintenance.
- Before touching any of connection wirings, be sure to turn off all power supply switches.
- Contact professional personnel about attachment of accessories and be sure to use only accessories specified by the manufacturer.
If a defect results from your own workmanship, it may result in water leaks, electric shock or fire.

⚠ CAUTION

- Before cleaning, be sure to stop unit operation, turn the breaker off or remove the power cord.
Otherwise, an electric shock and injury may result.
- Do not wash the air conditioner with water, as this may result in electric shocks or fire.
- Consult your dealer regarding cleaning the inside of the air conditioner.
Improper cleaning may cause breakage of plastic parts, water leakage and other damage as well as electric shocks.
- Take care of scaffolding and exercise caution when working high above ground level.

HOW TO CLEAN THE AIR FILTER

Clean the air filter when the display shows “” (TIME TO CLEAN AIR FILTER).

It will display that it will operate for a set amount of time. Increase the frequency of cleaning if the unit is installed in a room where the air is extremely contaminated. If the dirt becomes impossible to clean, change the air filter. (For changing air filter, please contact your dealer.)

1. Open the suction grille.

Pull it downward slowly while pressing the buttons provided on two spots.
(Do the same procedure for closing.)

Fig. 1

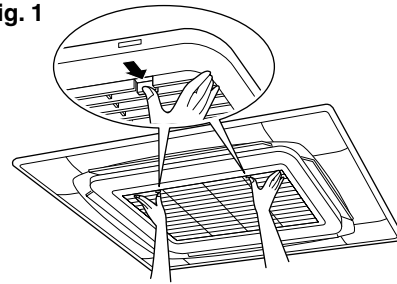

2. Remove the air filter.

Perform the operation in the order (1) and (2).

Fig. 2

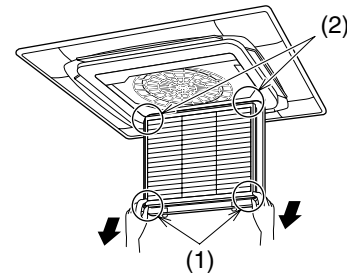

- (1) Pull the ends of the air filter down and remove the holes of the air filter from the grille protrusions. (Both left and right sides.)

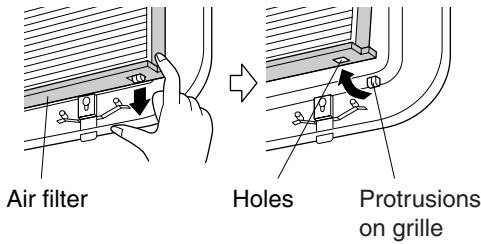

- (2) Lift the air filter and remove the holes of the air filter from the protrusions on the upper side of the grille. (Both left and right sides.)

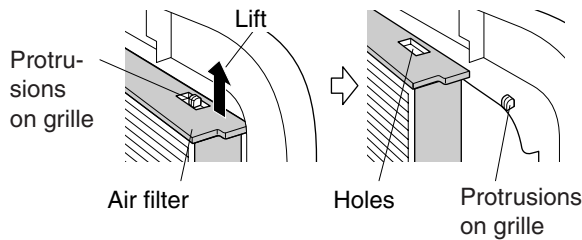

3. Clean the air filter.

Use vacuum cleaner **A)** or wash the air filter with water **B).**

A) Using a vacuum cleaner



B) Washing with water

When the air filter is very dirty, use soft brush and neutral detergent.



Remove water and dry in the shade.

NOTE

- Do not wash the air conditioner with hot water of more than 50°C, as doing so may result in discoloration and/or deformation.
- Do not expose it to fire, as doing so may result in burning.

4. Fix the air filter.

Refer to item No. 2.

5. Shut the suction grille.

Slowly push up the suction grille, and then securely hook it onto the decoration panel while pushing the two knobs.

PRECAUTION

- When closing the suction grille, the lace might be pinched. Make sure the lace has not come out of the suction grille before closing it.

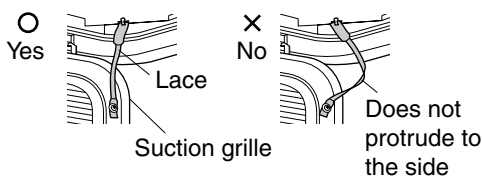

6. After turning on the power, press FILTER SIGN RESET button.

The "TIME TO CLEAN AIR FILTER" display vanishes.

HOW TO CLEAN AIR OUTLET AND OUTSIDE PANELS

- Clean with soft cloth.
- When dirt will not come off, remove it with a cloth wrung out of mild detergent diluted with water, and then wipe with a dry cloth.
- When the flap is extremely contaminated, remove it as below and clean or exchange it. (For changing the flap, please contact your dealer.)

NOTE

- Do not use gasoline, benzene, thinner, polishing powder, liquid insecticide. It may cause discoloring or warping.
- Do not let the indoor unit get wet. It may cause an electric shock or a fire.
- Do not scrub firmly when washing the blade with water. The surface sealing may peel off.
- Do not use water or air of 50°C or higher for cleaning air filters and outside panels.

HOW TO CLEAN THE SUCTION GRILLE

1. Open the suction grille.

Push it downward slowly while pressing the buttons provided on two spots. (Follow the same procedure for closing.)

Fig. 3

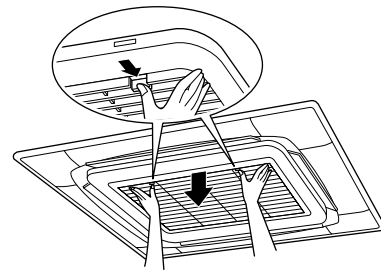

2. Remove the lace of the suction grille.

Remove the laces hooked on the two metal fittings of the panel body.

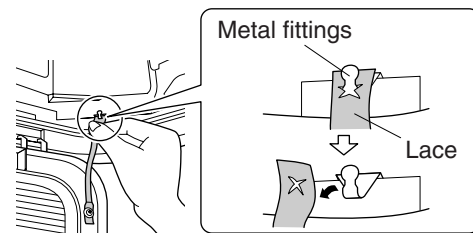

3. Detach the suction grille.

Open the suction grille 45 degrees and lift it upward.

Fig. 4

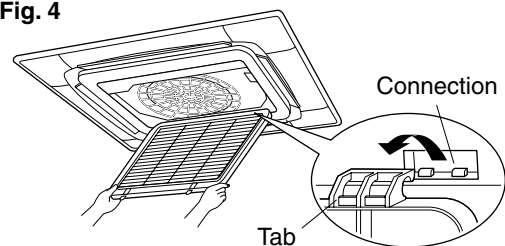

4. Detach the air filter.

Refer to "HOW TO CLEAN THE AIR FILTER".
(Refer to Fig. 2)

5. Clean the suction grille.

Wash with a soft bristle brush and neutral detergent or water, and dry thoroughly.



- **When very grimy**

Directly apply the type of detergent used for cleaning ventilation fans or ovens, wait 10 minutes, and then rinse with water.

6. Reattach the air filter.

Refer to "HOW TO CLEAN THE AIR FILTER".
(Refer to Fig. 2)

7. Reattach the suction grille.

Refer to item No. 2.

8. Fit the lace of the suction grille.

Fit in the reverse order of the procedure 2.

9. Close the suction grille.

Refer to item No. 1.

START UP AFTER A LONG STOP

Confirm the following.

- Check that the air inlet and outlet are not blocked. Remove any obstacle.
- Check if the earth is connected. Might there be a broken wire somewhere? Contact your dealer if there are any problems.

Clean the air filter and outside panels.

- After cleaning the air filter, make sure to attach it.

Turn on the main power supply switch.

- The display on the remote controller will be shown when the power is turned on.
- To protect the unit, turn on the main power switch at least 6 hours before operation.

WHAT TO DO WHEN STOPPING THE SYSTEM FOR A LONG PERIOD

Turn on FAN OPERATION for a half day and dry the unit.

- Read the operation manual attached to the remote controller.

Cut off the power supply.

- When the main power switch is turned on, some watts of electricity is being used even if the system is not operating. Turn off the main power supply switch for saving energy.
- The display on the remote controller will vanish when the main power switch is turned off.

Clean the air filter and the exterior.

- Be sure to replace the air filter to its original place after cleaning. Refer to "MAINTENANCE".

NOT MALFUNCTION OF THE AIR CONDITIONER

The following symptoms do not indicate air conditioner malfunction.

I. THE SYSTEM DOES NOT OPERATE

- **The system does not restart immediately after the ON/OFF button is pressed.**

If the OPERATION lamp lights, the system is in normal condition.

It does not restart immediately because a safety device operates to prevent overload of the system. After 3 minutes, the system will turn on again automatically.

- **The system does not restart immediately when TEMPERATURE SETTING button is returned to the former position after pushing the button.**

If the OPERATION lamp lights, the system is in normal condition.

It does not restart immediately because a safety device operates to prevent overload of the system. After 3 minutes, the system will turn on again automatically.

- **The system does not start when the display shows " " (UNDER CENTRALIZED CONTROL) and it flashes for a few seconds after pressing an operation button.**

This is because the system is under centralized control. Flashes on the display indicates that the system cannot be controlled by the remote controller.

- **The system does not start immediately after the power supply is turned on.**

Wait at least 5 minute until the micro computer is prepared for operation.

II. WHITE MIST COMES OUT OF A UNIT

- **When humidity is high during cooling operation. (In oily or dusty places)**

If the inside of an indoor unit is extremely contaminated, the temperature distribution inside a room becomes uneven. It is necessary to clean the inside of the indoor unit. Ask your dealer for details on cleaning the unit. This operation requires a qualified service person.

- **When the system is changed over to HEATING OPERATION after DEFROST OPERATION.**

Moisture generated by DEFROST becomes steam and exists.

III. NOISE OF AIR CONDITIONERS

- **A ringing sound after the unit is started.**

This sound is generated by the temperature regulator working.

It will quiet down after about a minute.

- **A continuous flow "Shuh" sound is heard when the systems is in COOLING or DEFROST OPERATION.**

This is the sound of refrigerant gas flowing through both indoor and outdoor units.

- **A "Shuh" sound which is heard at the start or immediately after the stop of operation or which is heard at the start or immediately after the stop of DEFROST OPERATION.**

This is the noise of refrigerant caused by flow stop and flow change.

- **A continuous low "Shah" sound is heard when the system is in COOLING OPERATION or at a stop.**

The noise is heard when the drain pump is in operation.

- **A "Pishi-pishi" squeaking sound is heard when the system is in operation or after the stop of operation.** Expansion and contraction of plastic parts caused by temperature change makes this noise.

IV. DUST FROM THE UNITS

- **Dust may blow out from the unit after starting operation from long resting time.**

Dust absorbed by the unit blows out.

V. THE UNITS GIVE OFF ODORS

The unit absorbs the smell of rooms, furniture, cigarettes, etc., and then emits them.

VI. THE LIQUID CRYSTAL OF THE REMOTE CONTROLLER SHOW " "

- **It happens immediately after the main power supply switch is turned on.**

This shows that the remote controller is in normal condition. This continues temporary.

TROUBLE SHOOTING

I. If one of the following malfunctions occurs, take the measures shown below and contact your dealer.

The system must be repaired by a qualified service person.

⚠ WARNING

- **When the air conditioner is in abnormal conditions (smell of something burning, etc), unplug the power cord from the outlet, and contact your dealer**
Continued operation under such circumstances may result in a failure, electric shock, and fire.

- If a safety device such as a fuse, a breaker or an earth leakage breaker frequently actuates;
Measure: Do not turn on the main power supply switch.
- If the ON/OFF button does not properly work;
Measure: Turn off the main power supply switch.
- If water leaks from unit.
Measure: Stop the operation.
- If the display “” (INSPECTION), “UNIT No.,” and the OPERATION lamp flash and the “MALFUNCTION CODE” appears.

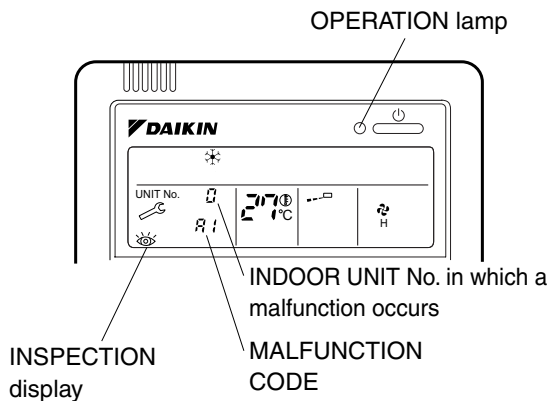

Measure: Notify your dealer and inform him/her of the display.

II. If the system does not properly operate except for the above mentioned case, and none of the above mentioned malfunctions is evident, investigate the system according to the following procedures.

1. If the system does not operate at all.

- Check if there is a power failure.
Wait until power is restored. If power failure occurs during operation, the system automatically restarts immediately after the power supply recovers.
- Check if a fuse has blown.
Turn off the power supply.
- Is the breaker blown?
Turn the power on with the breaker switch in the off position.
Do not turn the power on with the breaker switch in the trip position.
(Contact your dealer.)

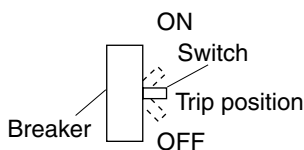

2. If the system stops operating after operating the system.

- Check if the air inlet or outlet of outdoor or indoor unit is blocked by obstacles.
Remove the obstacle and make it well-ventilated.
- Check if the air filter is clogged.
Ask a qualified service person to clean the air filters (Refer to MAINTENANCE).

3. The system operates but it does not sufficiently cool or heat.

- If the air inlet or outlet of the indoor or the outdoor unit is blocked with obstacles.
Remove the obstacle and make it well-ventilated.
- If the air filter is clogged.
Ask a qualified service person to clean the air filters (Refer to MAINTENANCE).
- If the set temperature is not proper (Refer to ADJUSTMENT).
- If the FAN SPEED button is set to LOW SPEED (Refer to ADJUSTMENT).
- If the air flow angle is not proper (Refer to ADJUSTING THE AIR FLOW DIRECTION).
- If the doors or the windows are open. Shut doors or windows to prevent wind from coming in.
- If direct sunlight enters the room (when cooling).
Use curtains or blinds.
- When there are too many inhabitants in the room (when cooling).
Cooling effect decreases if heat gain of the room is too large.
- If the heat source of the room is excessive (when cooling).
Cooling effect decreases if heat gain of the room is too large.

DAIKIN INDUSTRIES, LTD.

Head office:

Umeda Center Bldg., 2-4-12, Nakazaki-Nishi,
Kita-ku, Osaka, 530-8323 Japan

Tokyo office:

JR Shinagawa East Bldg., 2-18-1, Konan,
Minato-ku, Tokyo, 108-0075 Japan