

## Operating Instructions Air Conditioner



### Model No.

#### Indoor Unit

CS-E7PKR  
CS-E9PKR  
CS-E12PKR  
CS-E15PKR  
CS-E18PKR  
CS-E21PKR  
CS-E24PKR  
CS-E28PKR

#### Outdoor Unit

CU-E7PKR  
CU-E9PKR  
CU-E12PKR  
CU-E15PKR  
CU-E18PKR  
CU-E21PKR  
CU-E24PKR  
CU-E28PKR



### Operating Instructions Air Conditioner

Thank you for purchasing Panasonic Air Conditioner.  
Installation instructions attached.  
Before operating the unit, read these operating  
instructions thoroughly and keep them for future  
reference.

# Provide maximum comfort, clean air and optimise energy saving

## **ECONAVI and AUTO COMFORT**

Equipped with the human activity sensor, the air conditioner ensures to deliver cool or warm air to you, and keeps the room consistently comfortable with minimum energy consumption. See “To learn more...” for details.

## **nanoe-G**

Deactivates harmful micro-organisms such as viruses, bacteria, etc. to keep air clean. It also deactivates viruses and bacteria on the filter to keep inside of the unit clean.



# Quick guide

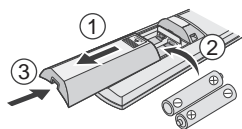

## Inserting the batteries

- ① Pull out the back cover of remote control
- ② Insert AAA or R03 batteries (can be used ~ 1 year)
- ③ Close the cover

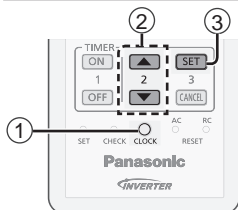

## Clock setting

- ① Press **CLOCK**
- ② Set the time
- ③ Confirm

## Basic operation

- ① Select the desired mode

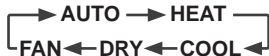

- ② Start/stop the operation

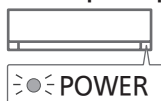

- Please note that the OFF indication **OFF** is on to start.

- ③ Select the desired temperature

- Selection range: 16°C ~ 30°C (Not applicable for FAN mode).
- Operating the unit within the recommended temperature may save energy.  
HEAT : 20 °C ~ 24 °C.  
COOL: 26 °C ~ 28 °C.  
DRY : 1 °C ~ 2 °C lower than room temperature.

- The set temperature selection range can be customized according to requirement. Please consult authorised dealer.

- To dim or restore the unit's indicator brightness, press  and hold for 5 seconds.
- Use remote control within 8 m from the remote control receiver of the indoor unit.

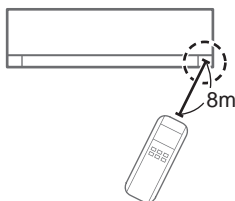
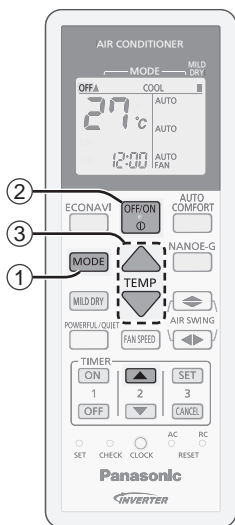

## Table of contents

Safety precautions.....	4-5
How to use.....	6-7
To learn more... ..	8-9
Cleaning instructions .....	10
Troubleshooting .....	11
Information.....	<b>Back cover</b>

## Accessories

- Remote control
- AAA or R03 batteries × 2
- Remote control holder
- Screws for remote control holder × 2

The illustrations in this manual are for explanation purposes only and may differ from the actual unit. They are subject to change without notice for future improvement.

# Safety precautions

To prevent personal injury, injury to others or property damage, please comply with the following:

Incorrect operation due to failure to follow instructions below may cause harm or damage, the seriousness of which is classified as below:

	<b>WARNING</b>	This sign warns of death or serious injury.
--	----------------	---

	<b>CAUTION</b>	This sign warns of injury or damage to property.
--	----------------	--

The instructions to be followed are classified by the following symbols:

	This symbol denotes an action that is <b>PROHIBITED</b> .
--	---

	These symbols denote actions <b>COMPULSORY</b> .
--	--

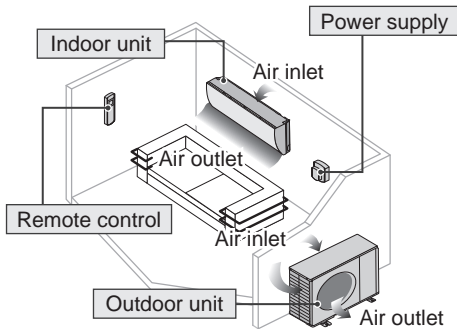

	<b>WARNING</b>
---	----------------

## Indoor unit and outdoor unit

 This appliance is not intended for use by persons (including children) with reduced physical, sensory or mental capabilities, or lack of experience and knowledge, unless they have been given supervision or instruction concerning use of the appliance by a person responsible for their safety. Children should be supervised to ensure that they do not play with the appliance.

Please consult authorised dealer or specialist to clean the internal parts, repair, install, remove and reinstall the unit. Improper installation and handling will cause leakage, electric shock or fire.

Confirm with authorised dealer or specialist on usage of any specified refrigerant type. Using refrigerant type other than the specified may cause product damage, burst and injury etc.

 Do not install the unit in a potentially explosive or flammable atmosphere. Failure to do so could result in fire.

Do not insert your fingers or other objects into the air conditioner indoor or outdoor unit, rotating parts may cause injury. 

Do not touch the outdoor unit during lightning, it may cause electric shock.



Do not expose yourself directly to cold air for a long period to avoid excess cooling.

Do not sit or step on the unit, you may fall down accidentally. 

## Remote control

 Do not allow infants and small children to play with the remote control to prevent them from accidentally swallowing the batteries.

## Power supply

 Do not use a modified cord, joint cord, extension cord or unspecified cord to prevent overheating and fire. 



To prevent overheating, fire or electric shock:

- Do not share the same power outlet with other equipment.
- Do not operate with wet hands.
- Do not over bend the power supply cord.
- Do not operate or stop the unit by inserting or pulling out the power plug.



If the supply cord is damaged, it must be replaced by the manufacturer, service agent or similarly qualified persons in order to avoid a hazard.

It is strongly recommended to be installed with Earth Leakage Circuit Breaker (ELCB) or Residual Current Device (RCD) to prevent electric shock or fire.

To prevent overheating, fire or electric shock:

- Insert the power plug properly.
- Dust on the power plug should be periodically wiped with a dry cloth.

Stop using the product if any abnormality/failure occurs and disconnect the power plug or turn off the power switch and breaker.

(Risk of smoke/fire/electric shock) Examples of abnormality/failure

- The ELCB trips frequently.
- Burning smell is observed.
- Abnormal noise or vibration of the unit is observed.
- Water leaks from the indoor unit.
- Power cord or plug becomes abnormally hot.
- Fan speed cannot be controlled.
- The unit stops running immediately even if it is switched on for operation.
- The fan does not stop even if the operation is stopped.

Contact your local dealer immediately for maintenance/repair.



This equipment must be earthed to prevent electrical shock or fire.



Prevent electric shock by switching off the power supply and unplugging:

- Before cleaning or servicing,
- When extended non-use, or
- During abnormally strong lightning activity.



**CAUTION**

### Indoor unit and outdoor unit



Do not wash the indoor unit with water, benzene, thinner or scouring powder to avoid damage or corrosion at the unit.



Do not use for preservation of precise equipment, food, animals, plants, artwork or other objects. This may cause quality deterioration, etc.

Do not use any combustible equipment in front of the airflow outlet to avoid fire propagation.

Do not expose plants or pet directly to airflow to avoid injury, etc.

Do not touch the sharp aluminium fin, sharp parts may cause injury.



Do not switch ON the indoor unit when waxing the floor. After waxing, aerate the room properly before operating the unit.

Do not install the unit in oily and smoky areas to prevent damage to the unit.

Do not dismantle the unit for cleaning purpose to avoid injury.

Do not step onto an unstable bench when cleaning the unit to avoid injury.

Do not place a vase or water container on the unit. Water may enter the unit and degrade the insulation. This may cause an electric shock.

Do not open window or door for long time during COOL/DRY mode operation.



Prevent water leakage by ensuring drainage pipe is:

- Connected properly,
- Kept clear of gutters and containers, or
- Not immersed in water

After a long period of use or use with any combustible equipment, aerate the room regularly.

After a long period of use, make sure the installation rack does not deteriorate to prevent the unit from falling down.

### Remote control



Do not use rechargeable (Ni-Cd) batteries. It may damage the remote control.



To prevent malfunction or damage of the remote control:

- Remove the batteries if the unit is not going to be used for a long period of time.
- New batteries of the same type must be inserted following the polarity stated.

### Power supply



Do not disconnect the plug by pulling the cord to prevent electric shock.

# How to use

ECONAVI

 To optimise energy saving

 ECONAVI

**MODE** To select operation mode

**AUTO** - For your convenience

**HEAT** - To enjoy warm air

**COOL** - To enjoy cool air

**DRY** - To dehumidify the environment

**FAN** - To circulate air in the room

**MILD DRY** To improve humidity and moisture level

- This operation reduces air dryness and provides you with a comfortable living environment during COOL mode only.
- When vertical airflow direction is set to AUTO, it stops at lower position to avoid cold air contact. However, you can adjust the louver direction manually.

**POWERFUL/QUIET** To switch between powerful & quiet

→ POWERFUL → QUIET → NORMAL

**POWERFUL:** To reach temperature quickly

 POWERFUL

- This operation stops automatically after 4 hours.

**QUIET:** To enjoy quiet operation

 QUIET

- This operation reduces airflow noise.

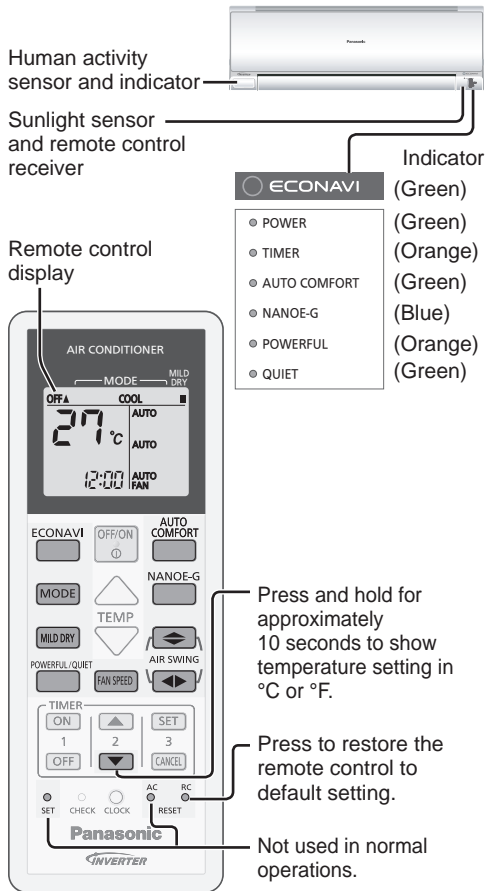

**FAN SPEED** To select fan speed

(Remote control display)



- For AUTO, the indoor fan speed is automatically adjusted according to the operation mode.

## Auto OFF/ON button

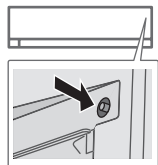

Use when remote control is misplaced or a malfunction occurs. Raise the front panel:

- To use in AUTO mode, press the button once.
- To use in COOL mode, press and hold the button until 1 beep is heard, then release.
- To use in HEAT mode, press and hold the button until 1 beep is heard, then release. And press again until 2 beeps are heard, then release.
- Press the button again to turn off.



### To maximise comfort

☉ AUTO COMFORT



### To purify the air

☉ NANO-E-G

- nanoe-G starts automatically when the unit is turned on with .
- Can be activated even when the unit is turned off. In this condition, the unit will operate as a fan with AUTO fan speed and louver swing.

### To deactivate viruses/bacteria on the filter

☉ NANO-E-G ● POWER

- After the unit is turned off, the nanoe-G in-filter deactivation may activate up to 150 minutes. Turning on the unit cancels this operation.
- To disable this operation in the future, press and hold until a short beep sound is heard. This will not disable the nanoe-G to purify the air.
- To restore the nanoe-G in-filter deactivation, press and hold until a long beep sound is heard.



### To adjust airflow direction

(Remote control display)



- Keeps the room ventilated.
- In COOL/DRY mode, if AUTO is set, the louver swings left/right and up/down automatically.
- In HEAT mode, if AUTO is set, the horizontal louver is fixed at the predetermined position. The vertical louver swings left/right after the temperature rises.
- Do not adjust the louver by hand.

### To set the timer

2 sets of ON and OFF timers are available to turn ON or OFF the unit at different preset times.

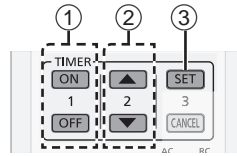

#### ① Select ON or OFF timer

- Each time pressed:

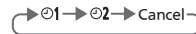

#### ② Set the time

Example:  
OFF at 22:00



#### ③ Confirm



- To cancel ON or OFF timer, press or to select respective ① or ② then press .
- If timer is cancelled manually or due to power failure, you can restore the timer again by pressing or to select respective ① or ② then press .
- The nearest timer setting will be displayed and will activate in sequence.
- When ON Timer is set, the unit may start earlier (up to 35 minutes) before the actual set time in order to achieve the desired temperature on time.
- Timer operation is based on the clock set in the remote control and repeats daily once set. For clock setting, please refer to Quick guide.

### Note



- Can be activated in all modes and can be cancelled by pressing the respective button again.



- Cannot be selected at the same time.
- Cannot be activated during MILD DRY COOLING.

# To learn more...

## Operation mode

**AUTO** : During operation mode selection the POWER indicator blinks.

• Unit selects operation mode every 10 minutes according to setting temperature and room temperature.

**HEAT** : Unit takes a while to warm up. The POWER indicator blinks during this operation.

**COOL** : Use curtains to screen off sunlight and outdoor heat to reduce power consumption during COOL mode.

**DRY** : Unit operates at low fan speed to give a gentle cooling operation.

**FAN** : To circulate air in the room

## nanoe-G in-filter deactivation

Depending on the unit's accumulated operation time, nanoe-G in-filter deactivation may activate only once a day after the unit turned off.

To remove the moisture left in the internal parts, the fan will operate for 30 minutes with louver opened slightly. This process only applicable when the unit is operated in COOL/DRY mode before turned off. Then, nanoe-G deactivates viruses/bacteria on the filter for 2 hours with fan stopped and louver closed.

Do not turn off the power supply during this operation. After power failure, this operation will not resume.

## ECONAVI and AUTO COMFORT

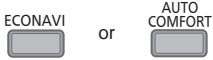

The unit will start to initialise (for approximately 1 minute)



The human activity sensor and the sunlight sensor will start to detect.

### Note



When manual AIR SWING is selected, the ECONAVI and AUTO COMFORT operations will be cancelled.

## Human activity sensor operation

**ECONAVI** ; Detecting human presence and activity, the unit controls room temperature to save energy.

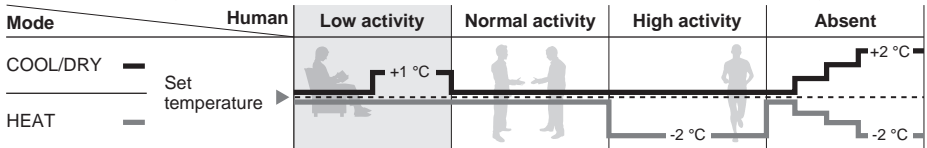

**AUTO COMFORT** ; Detecting human presence and activity, the unit controls room temperature to keep human comfortable consistently.

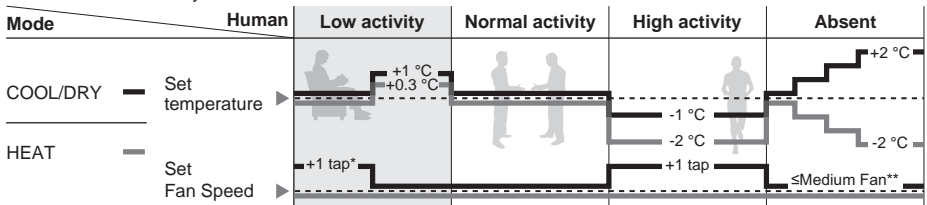

### ECONAVI and AUTO COMFORT

Precise control of temperature during low activity to maximise energy saving.

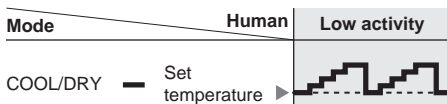

ECONAVI and AUTO COMFORT take advantage of the human nature that human being takes time to feel the temperature rise during low activity level; the unit adjusts temperature to maximise energy saving without sacrificing the comfort.

\* During low activity, fan speed 1 tap up for first 15 minutes or until set temperature is reached.

\*\* During human absence, maximum fan speed for COOL/DRY mode is medium fan.



The human activity sensor will also scan for area of heat source and movement in a room.

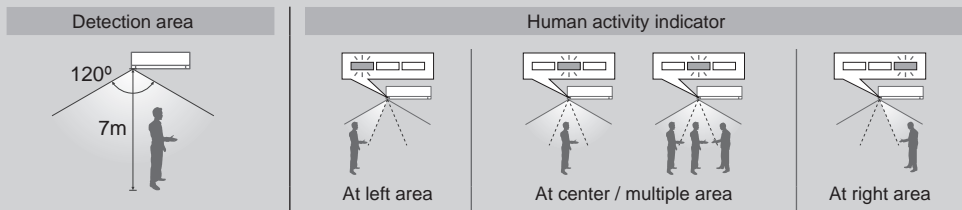

The unit judges human activity area for a few seconds before indicator updates. Based on area activeness horizontal airflow direction louver will adjust either fix at predetermined position or swing left/right periodically.

- The human activity sensor performance is influenced by indoor unit location, movement speed, temperature range, etc.
- The human activity sensor may:
  - mistakenly detect an object with heat source & movement similar to human, such as pets, etc.
  - mistakenly detect as non-heat source & movement if a human stays motionless for certain period of time.
- Do not place large objects near the sensor and keep away heating units or humidifier from the sensor's detection area. They may cause sensor malfunction.

### Sunlight Sensor operation

**ECONAVI** ; Detecting sunlight intensity, the unit adjust temperature to save energy.

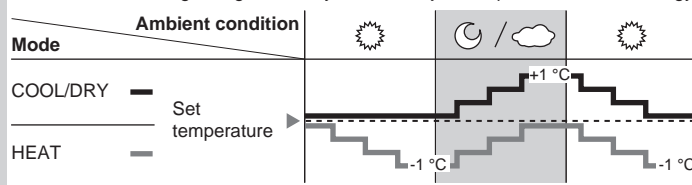

ECONAVI is activated, the unit maintains set temperature until a high sunlight intensity is detected. The sunlight sensor detects sunlight intensity during weather or day/night changes, and the unit adjusts temperature.

- In a room without window or with thick curtain, the sunlight sensor will judge as cloudy/night.

### Operation conditions

Use this air conditioner under the following temperature range.

DBT : Dry bulb temperature

WBT : Wet bulb temperature

Temperature (°C)		Indoor		Outdoor	
		DBT	WBT	DBT	WBT
COOL	Max.	32	23	46	26
	Min.	16	11	5	4
HEAT	Max.	30	-	24	18
	Min.	16	-	-15	-16

To learn more...

English

# Cleaning instructions

To ensure optimal performance of the unit, cleaning has to be carried out at regular intervals. Dirty unit may cause malfunction and you may see error code "H99". Please consult authorised dealer.

- Switch off the power supply and unplug before cleaning.
- Do not touch the aluminium fin, sharp parts may cause injury.
- Do not use benzine, thinner or scouring powder.
- Use only soap ( $\approx$  pH 7) or neutral household detergent.
- Do not use water hotter than 40 °C.

## Indoor unit

Wipe the unit gently with a soft, dry cloth.



## Human activity sensor

Do not hit or violently press or poke it with a sharp object. This can lead to damage and malfunction.

## Front panel

Wash gently and dry.

## Remove the front panel

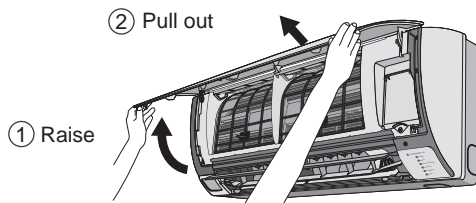

## Close it securely

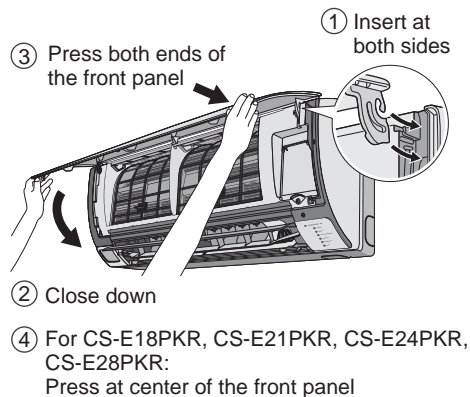

## Indoor unit

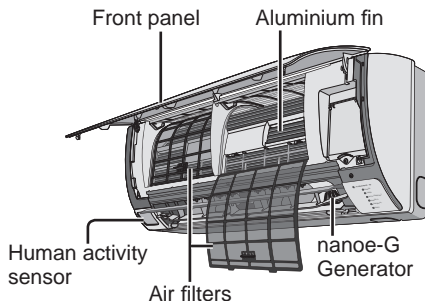

## nanoe-G Generator

Every 6 months

- Clean with dry cotton bud.
- Do not touch during operation.

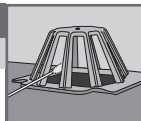

## Air filters

Every 2 weeks

- Wash/rinse the filters gently with water to avoid damage to the filter surface.
- Dry the filters thoroughly under shade, away from fire or direct sunlight.
- Replace any damaged filters.



## Remove air filter

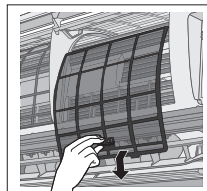

## Attach air filter

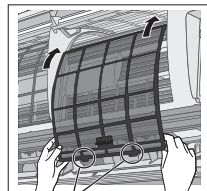

Insert into the unit

## For seasonal inspection after extended non-use

- Checking of remote control batteries.
- No obstruction at air inlet and air outlet vents.
- Use Auto OFF/ON button to select COOL/HEAT operation. After 15 minutes of operation, it is normal to have the following temperature difference between air inlet and air outlet vents:

COOL:  $\geq 8$  °C    HEAT:  $\geq 14$  °C

## For extended non-use

- Activate HEAT mode for 2-3 hours to remove moisture left in the internal parts thoroughly to prevent mould growth.
- Turn off the power supply and unplug.
- Remove the remote control batteries.

# Troubleshooting

The following symptoms do not indicate malfunction.

Symptom	Cause
Mist emerges from indoor unit.	• Condensation effect due to cooling process.
Water flowing sound during operation.	• Refrigerant flow inside the unit.
The room has a peculiar odour.	• This may be due to damp smell emitted by the wall, carpet, furniture or clothing.
Indoor fan stops occasionally during automatic fan speed setting.	• This helps to remove the surrounding odour.
Airflow continues even after operation has stopped.	• Extraction of remaining heat from the indoor unit (maximum 30 seconds).
Operation is delayed a few minutes after restarting.	• The delay is a protection to the unit's compressor.
Outdoor unit emits water/steam.	• Condensation or evaporation occurs on pipes.
TIMER indicator is always on.	• The timer setting repeats daily once set.
POWER indicator blinks during HEAT mode with no warm air supply (and louver is closed).	• The unit is in defrost mode (and AIR SWING is set to AUTO).
Indoor fan stops occasionally during heating operation.	• To avoid unintended cooling effect.
POWER indicator blinks before the unit is switched on.	• This is a preliminary step in preparation for the operation when the ON timer has been set.
Cracking sound during operation.	• Changes of temperature caused the expansion/contraction of the unit.
2 or more human activity indicator turns on simultaneously.	• Judgement of heat source and movement area in progress.
POWER indicator blinks 3 seconds ON and 0.5 seconds OFF during operation.	• The unit is in Demand Response Mode.

Check the following before calling for servicing.

Symptom	Check
Operation in HEAT/COOL mode is not working efficiently.	<ul style="list-style-type: none"> <li>• Set the temperature correctly.</li> <li>• Close all doors and windows.</li> <li>• Clean or replace the filters.</li> <li>• Clear any obstruction at the air inlet and air outlet vents.</li> </ul>
Noisy during operation.	<ul style="list-style-type: none"> <li>• Check if the unit has been installed at an incline.</li> <li>• Close the front panel properly.</li> </ul>
Remote control does not work. (Display is dim or transmission signal is weak.)	<ul style="list-style-type: none"> <li>• Insert the batteries correctly.</li> <li>• Replace weak batteries.</li> </ul>
The unit does not work.	<ul style="list-style-type: none"> <li>• Check if the circuit breaker is tripped.</li> <li>• Check if timers have been set.</li> </ul>
The unit does not receive the signal from the remote control.	<ul style="list-style-type: none"> <li>• Make sure the receiver is not obstructed.</li> <li>• Certain fluorescent lights may interfere with signal transmitter. Please consult authorised dealer.</li> </ul>

## NON SERVICEABLE CRITERIAS

TURN OFF POWER SUPPLY AND UNPLUG then please consult authorised dealer under the following conditions:

- Abnormal noise during operation.
- Water/foreign particles have entered the remote control.
- Water leaks from Indoor unit.
- Circuit breaker switches off frequently.
- Power cord becomes unnaturally warm.
- Switches or buttons are not functioning properly.

## The unit stops and the TIMER indicator blinks.

Use remote control to retrieve error code.

- Press for 5 seconds
- Press until you hear beep sound, then write down the error code
- Press for 5 seconds to quit checking
- Turn the unit off and reveal the error code to authorised dealer

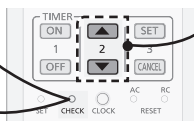

- For certain errors, you may restart the unit for limited operation with 4 beeps when operation starts.

# Information

English

## Information for Users on Collection and Disposal of Old Equipment and used Batteries



### [Information on Disposal in other Countries outside the European Union]

These symbols are only valid in the European Union. If you wish to discard these items, please contact your local authorities or dealer and ask for the correct method of disposal.



### Note for the battery symbol (bottom two symbol examples):

This symbol might be used in combination with a chemical symbol. In this case it complies with the requirement set by the Directive for the chemical involved.



Pb

**Panasonic Corporation**

Website: <http://panasonic.net/>

© Panasonic Corporation 2013

Printed in Malaysia

**F569361**  
FA0413-0