

## STEEL TUBULAR RADIATORS



## ELEGANT AND STYLISH

Contemporary, elegant and stylish – tubular radiators can be used as an architectural feature of your home while combining looks and warmth in one superior product.

Manufactured with great attention to appearance – a key feature of the tubular radiators is the perfectly smooth lustrous finish without any traces of weld joints, allowing you to make a statement or blend with any interior décor.

*If you need confirmation of quality, every De Longhi radiator has a 25 year guarantee against design or manufacturing defects from the date of installation.*

### finishes

High gloss white.

### measurements

Available as 2, 3, 4, 5, 6 columns in various heights Each section width 46mm.

Radiators supplied to order only

For full details PTO



# STEEL TUBULAR RADIATORS

TABLES BASED ON  $\Delta T 50$  - MEAN WATER TEMPERATURE IN RADIATOR OF  $70^{\circ}\text{C}$  AND ROOM TEMPERATURE OF  $20^{\circ}\text{C}$ .  $\Delta T 60$  - MEAN WATER TEMPERATURE IN RADIATOR OF  $80^{\circ}\text{C}$  AND ROOM TEMPERATURE OF  $20^{\circ}\text{C}$  - RADIATOR OUTPUTS TO EN442 STANDARD

Height	# Columns	Output Kw $\Delta t 50$ $\Delta t 60$	Height	# Columns	Output Kw $\Delta t 50$ $\Delta t 60$	Height	# Columns	Output Kw $\Delta t 50$ $\Delta t 60$	Height	# Columns	Output Kw $\Delta t 50$ $\Delta t 60$	
300	2	0.024 0.030	750	2	0.055 0.069	1500	2	0.106 0.135	2500	2	0.180 0.229	
	3	0.033 0.042		3	0.074 0.094		3	0.144 0.183		3	0.246 0.312	
	4	0.042 0.053		4	0.100 0.126		4	0.194 0.247		4	0.322 0.409	
	5	0.052 0.065		5	0.119 0.151		5	0.228 0.291		5	0.380 0.483	
	6	0.062 0.078		6	0.144 0.183		6	0.276 0.351		6	0.452 0.576	
400	2	0.031 0.039	900	2	0.065 0.082	1800	2	0.128 0.162	2800	2	0.204 0.259	
	3	0.042 0.053		3	0.088 0.111		3	0.174 0.221		3	0.279 0.354	
	4	0.055 0.070		4	0.119 0.150		4	0.232 0.295		4	0.362 0.458	
	5	0.067 0.085		5	0.141 0.179		5	0.273 0.349		5	0.427 0.542	
	6	0.081 0.102		6	0.171 0.217		6	0.329 0.419		6	0.506 0.644	
500	2	0.038 0.048	1000	2	0.072 0.091	2000	2	0.142 0.181	3000	2	0.218 0.277	
	3	0.052 0.065		3	0.097 0.123		3	0.194 0.246		3	0.302 0.383	
	4	0.068 0.086		4	0.131 0.166		4	0.258 0.328		4	0.388 0.491	
	5	0.082 0.104		5	0.155 0.197		5	0.303 0.387		5	0.459 0.583	
	6	0.099 0.125		6	0.188 0.240		6	0.364 0.464		6	0.542 0.690	
600	2	0.045 0.056	1200	2	0.086 0.108	2200	2	0.157 0.200	*Other heights available on request			
	3	0.061 0.076		3	0.116 0.147		3	0.214 0.272				
	4	0.081 0.102		4	0.157 0.198		4	0.283 0.360				
	5	0.097 0.122		5	0.185 0.235		5	0.333 0.425				
	6	0.117 0.149		6	0.224 0.285		6	0.399 0.508				

Each section width 46mm

## INSTALLING DIMENSIONS DE LONGHI STEEL TUBULAR RADIATORS

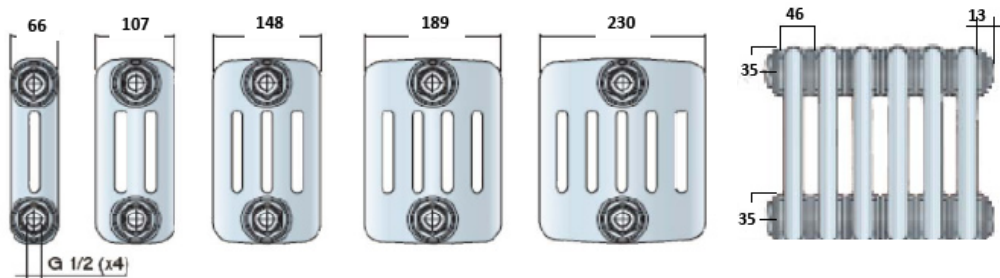

OPTIONAL INSTALLATION WITH FEET (AVAILABLE AT EXTRA COST)

TYPE A FOOT FOR 2 COLUMN

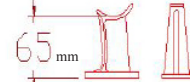

TYPE B FOOT FOR ALL OTHER SECTIONS

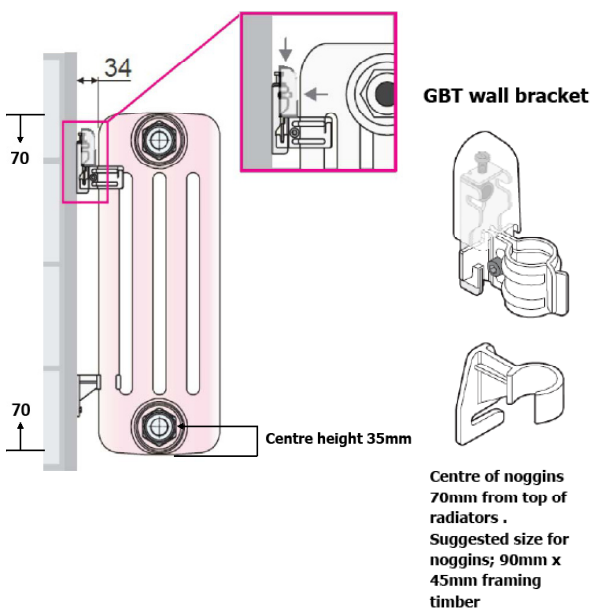
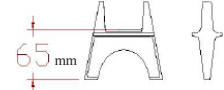

### \*CONNECTION POSSIBILITIES

standard

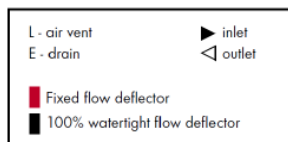
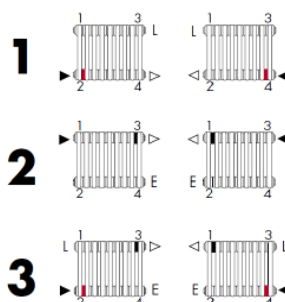

The standard configuration has four 1/2" reductions and one 1/2" pre-mounted blanking plug.

Types 1,2,3 connections (1/2" female thread)  
Types A,B,C,D,E,F connections (1/2" female thread)  
Type M connection (3/4" Male Thread)

from/to upper side/lower side

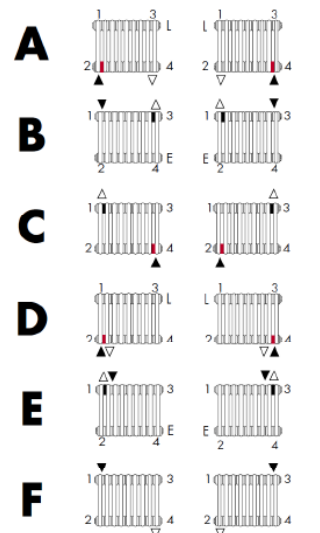

centre connection

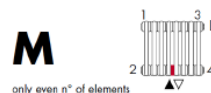

\*PLEASE NOTE: FOR CONNECTIONS POSSIBILITIES AS SHOWN ABOVE - ADDITIONAL COST PER RADIATOR APPLIES - CONTACT OUR SALES TEAM



hunt heating

showroom 11 Fiveways Boulevard Keysborough VIC 3173

phone 1300 00 1800 fax (+613) 9798 5133

email enquiries@huntheat.com.au website www.huntheat.com.au