



**With Integrated AC Unit Control**

# Installation and User Manual

# Table of contents

<b>Section</b>	<b>Description</b>	<b>Page No.</b>
<b>1.0 Installation</b>		<b>4</b>
1.1	Standard wiring layout for open / close zone system	4
1.2	Wiring layout when temperature controlled zones are installed	5
1.3	Wiring when more that 3 colour touch screens are installed	6
1.4	Installation instructions	7
<b>2.0 System initialisation</b>		<b>8</b>
2.1	System configuration	9
2.2	Change the password	9
2.3	Set the number of zones	9
2.4	Set the number of constants	9
2.5	Change the tag lines	9
2.6	Lock / unlock user airflow volume adjustment	9
2.7	Zone set up	10
2.8	AC unit configuration	11

# Table of contents

Section	Description	Page No.
<b>3.0</b>	<b>User manual</b>	12
3.0	Home screen	12
3.1	AC unit	13
3.2	Zone control	14
3.2.1	Edit zone names and settings	15
3.2.2	Adjusting temperature controlled zones	16
3.3	Zone airflow summary	17
3.3.1	Changing zone airflow	18
3.4	Favourites	19
3.4.1	Assign and edit favourites	20
3.5	Schedules	21
3.5.1	Setting and editing a schedule	22
3.6	Setting the time	23
3.7	Setting the home screen colour	24
3.8	Further assistance	25

# 1.1 Standard wiring layout for open / close zone system

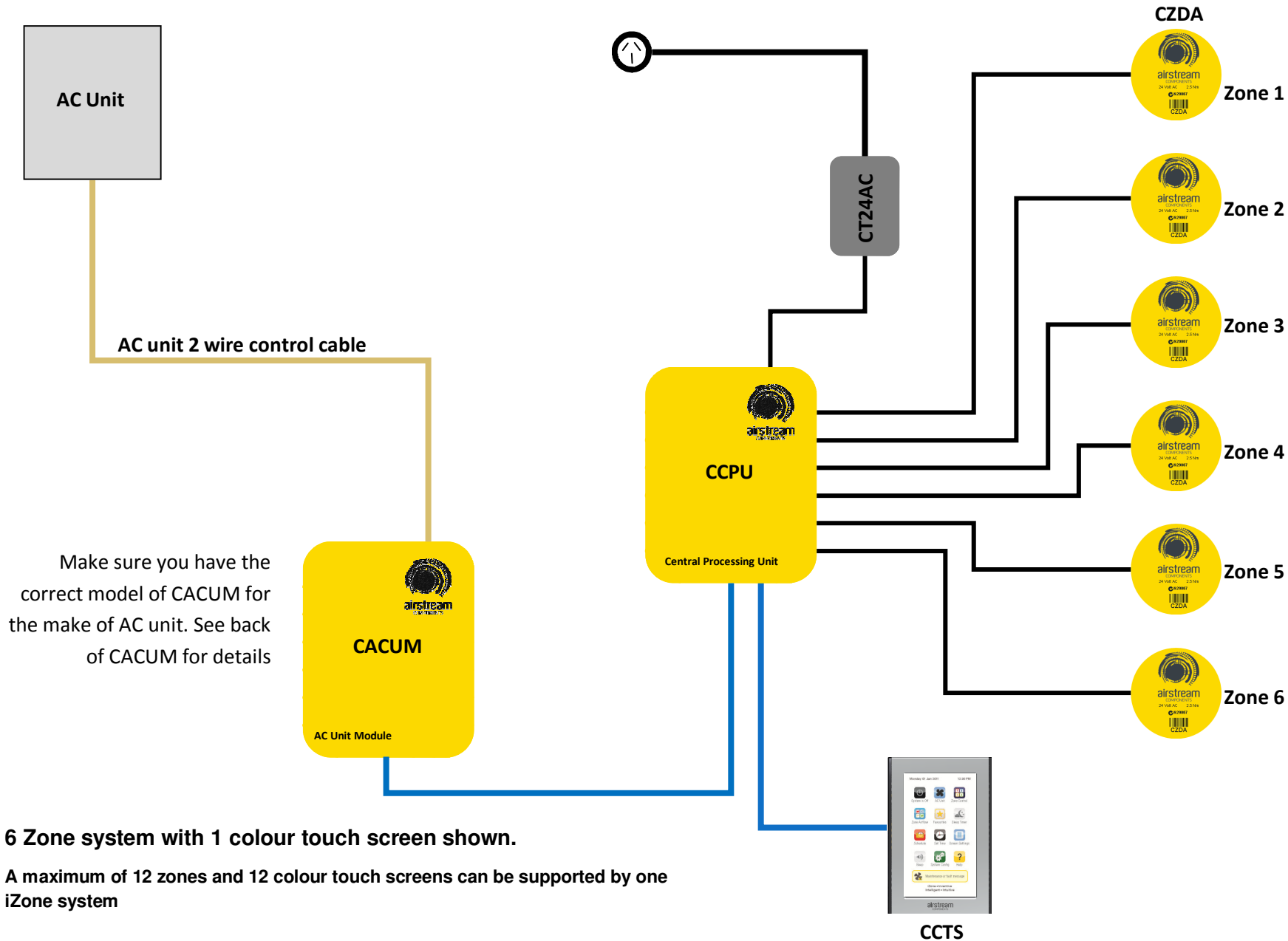



# 1.3 Wiring when more than 3 colour touch screens are installed

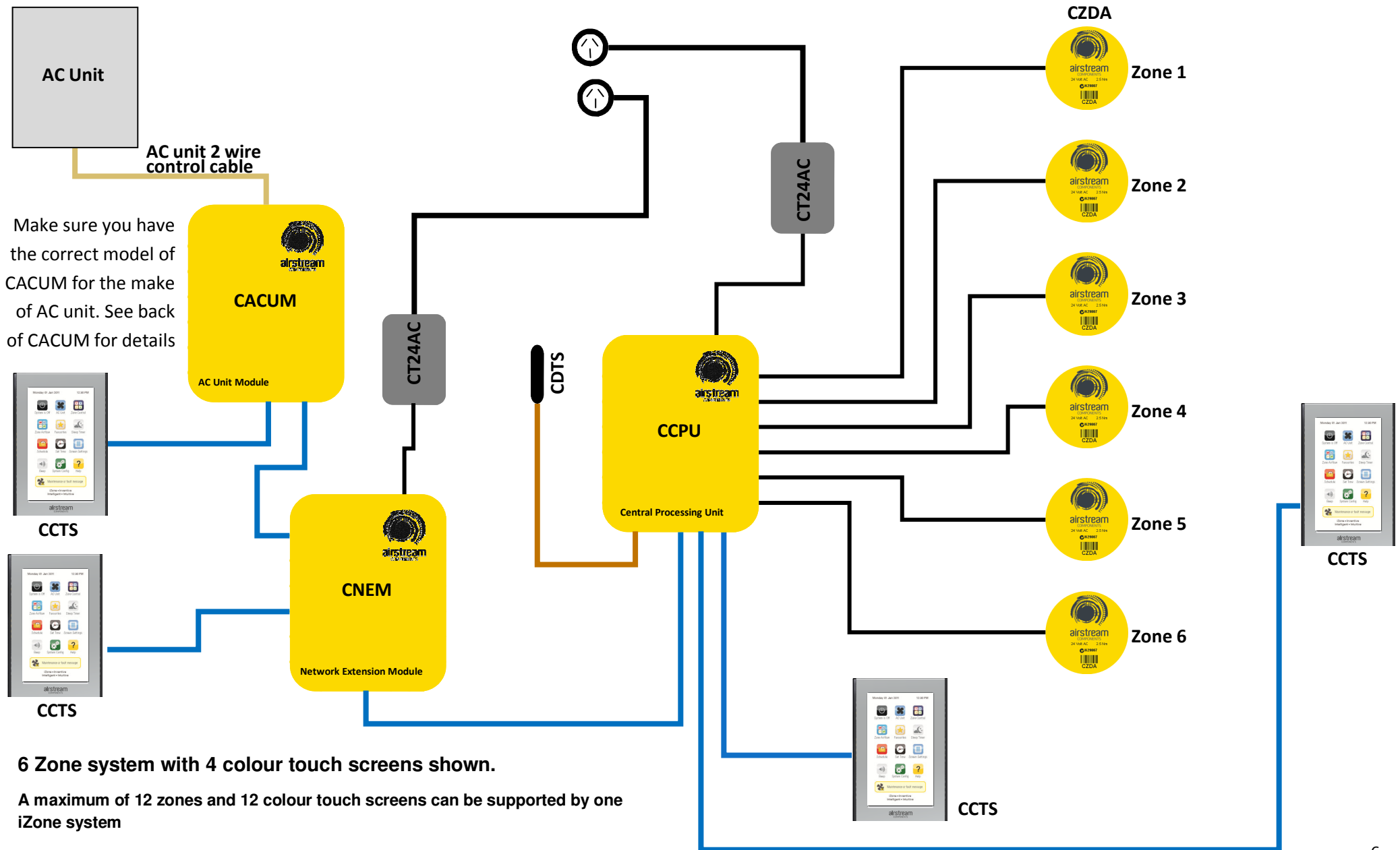

# 1.4 Installation instructions

1. The CCPU and CACUM can be installed on top of the indoor fan coil unit.
2. Do **not** run the blue network cables alongside 240 Volt wiring.
3. When installing network cables down wall cavities or chasing network cables into walls, tape up and protect the RJ45 connector to avoid damage to the connectors.
4. Always install zones in consecutive ports starting at Zone 1. The back of the CCPU is marked with the zone port numbers.
5. Do not directly hardwire the CT24V into the AC unit's power supply. This may void the warranty as it will require an electrician in the event that a repair of the iZone system is required.
6. Connect Zone Damper Actuators (CZDA) to the zone ports using the RJ11 cables as shown.
7. Connect the Colour Touch Screens (CCTS) to the CCTS ports using the RJ45 cables. If you are connecting more than 3 CCTS to the system you will need to connect a Network Extension Module (CNEM) to the CCPU using a short RJ45 cable. The CACUM will also support one CCTS.
8. If any CCTS is being used for zone temperature control connect a Duct Temperature Sensor (CDTS) to the CDTS port. Install the sensor into the supply air duct upstream of all dampers. Secure the sensor in place by using reinforced aluminium tape.
9. When installing temperature controlled zones ensure the CCTS for the associated zone is installed in a location that is representative of the temperature in the room / zone . The CCTS should be installed at approximately 1600mm above the floor and should not be subject to draughts, direct sunlight or heat from equipment such as computers, TV screens etc. The supply air outlets to this room must **not** blow conditioned air directly onto the touch screen, as the temperature sensor is located in the CCTS.
10. Connect the AC unit control cable from the fan coil unit controls to the CACUM. (This cable is supplied by the AC unit manufacturer and is normally used to connect the fan coil unit controls to the AC unit wall controller.
11. Only connect the power supply to the CT24VAC port after all components have been connected.

## 2.0 System initialisation

All new or modified systems must be initialised prior to system configuration.

To initialise the system press the button on the underside of any colour touch screen. This button is recessed so you will need to use a pen to press the button.

The time to initialise the system will vary depending on the number of motors connected.

The system will also initialise when power is restored after a power failure.

Airstream logo will spin while system is initialising.

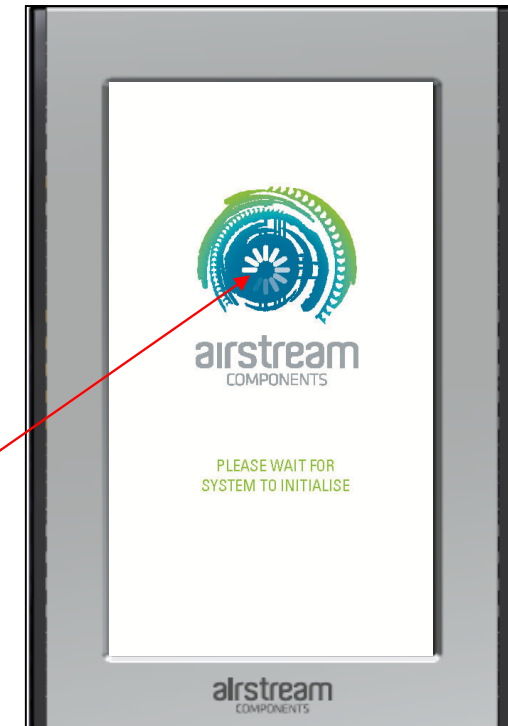

Using a pen, press the button on the underside of the screen.





# 2.1 System configuration

**WARNING !** Only qualified iZone installers should configure the iZone System. Incorrect configuration could result in damage to your air conditioning unit and system.



2.1 To configure your system click on the System Config icon on the home page.

Enter the system password “**wamfud**” and press the enter button. The enter button must always be touched to save changes. 

2.2-2.5 You will now be in the System Configuration area:

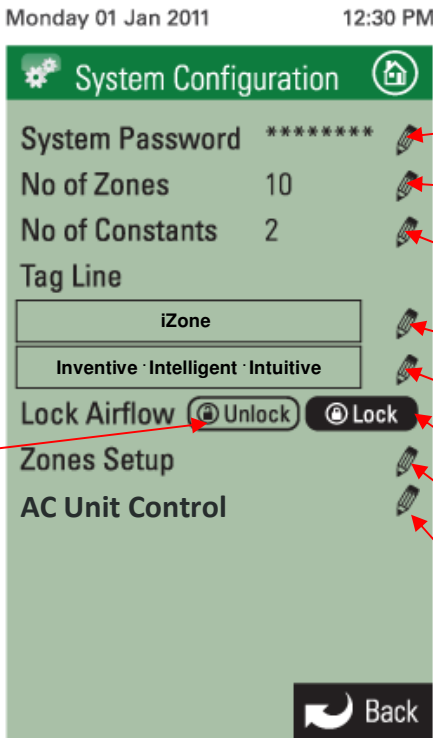

The screenshot shows the 'System Configuration' screen with the following elements and annotations:

- Monday 01 Jan 2011** and **12:30 PM** at the top.
- System Configuration** header with a gear icon and a home icon.
- System Password** field with asterisks and a pencil icon. Annotation: "Touch here to change the password."
- No of Zones** field with value 10 and a pencil icon. Annotation: "Touch here to edit the number of zones installed."
- No of Constants** field with value 2 and a pencil icon. Annotation: "Touch here to edit the number of variable electronic constant zones required."
- Tag Line** field with a pencil icon. Annotation: "Touch here to edit the first tag line."
- iZone** field with a pencil icon. Annotation: "Touch here to edit the second tag line."
- Inventive · Intelligent · Intuitive** field with a pencil icon.
- Lock Airflow** field with **Unlock** and **Lock** buttons. Annotation: "Touch here to lock the airflow adjustment function on the user screens."
- Zones Setup** field with a pencil icon. Annotation: "Touch here to set up and configure each zone (see 2.7)."
- AC Unit Control** field with a pencil icon. Annotation: "Touch here to set up AC Unit control (see 2.8)."
- Back** button at the bottom right.

Touch here to unlock the airflow adjustment function on the user screens.

iZone  
Inventive · Intelligent · Intuitive

## 2.7 Zone set up

Monday 01 Jan 2011 12:30 PM

Zone 1

80% Max Airflow

10% Min Airflow

Constant No 9

Climate Control

Open / Close

Next Previous Back

**iZone**  
Inventive · Intelligent · Intuitive

This is the zone that is currently being configured. If the zone has been named its name will show here

Touch here to go to the home screen

Touch here to increase the maximum airflow to the zone

Touch here to decrease the maximum airflow to the zone

Touch here to increase the minimum airflow to the zone

Touch here to decrease the minimum airflow to the zone

Touch here to make this zone an electronic variable constant

Touch here to make this zone a temperature controlled zone. This must only be done from the screen installed in the temperature controlled zone

Touch here to make this zone an open / close zone

Touch here to proceed to the next zone

Touch here repeatedly if more than one constant zone is required. This will step through the constant numbers. Select which constant you want this zone to be

# 2.8 AC unit configuration

Select method of controlling the AC unit.

- R/Air will control using the unit's return air sensor.
- Master will control the AC unit from the colour touch screen that has been selected as the Master (3.1).
- Zones will automatically control the AC unit from the temperature controlled zones (3.1.2).

Toggle the high and low buttons to select the maximum and minimum temperature set points desired for "Economy Lock Mode".

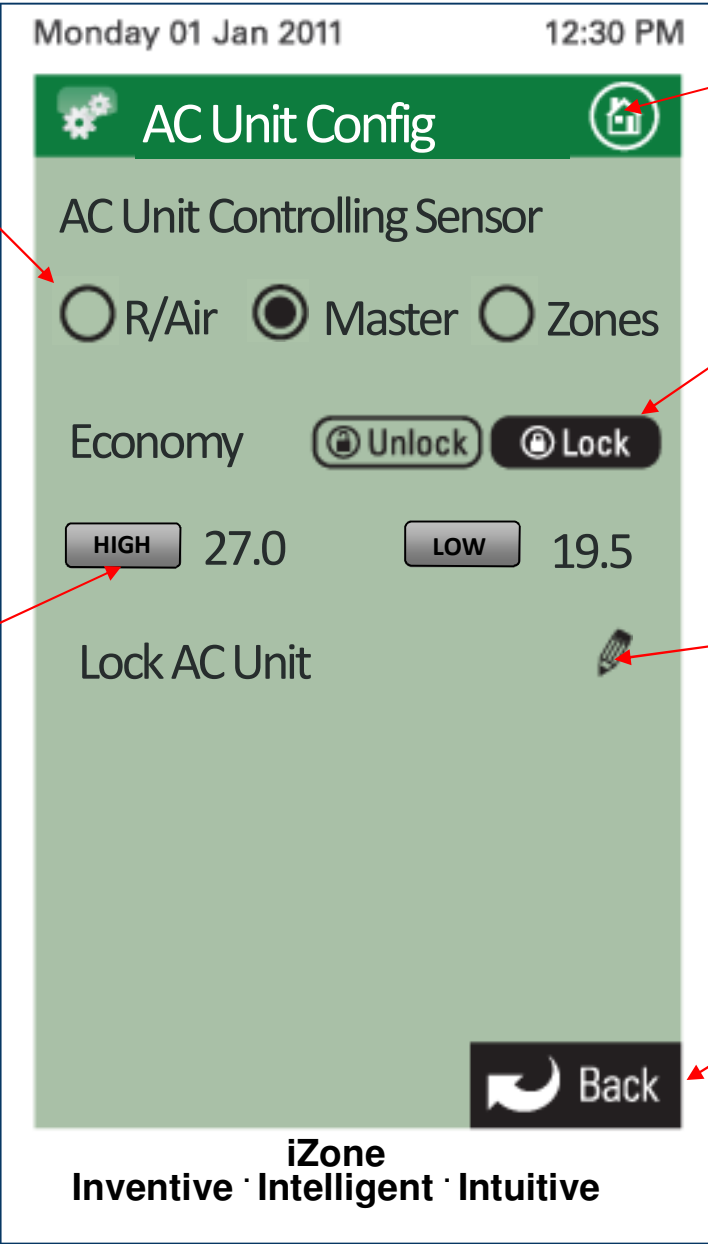

Touch here to go to the home screen.

Touch to lock the Economy mode. The Economy mode will limit the maximum and minimum temperature the system can be set to control at.

Touch to lock the AC Unit. You will need to enter a PIN number and the number of days the system will operate until it is locked off. Do not forget your PIN. Service charges will apply for a technician to attend site to unlock your system.

Touch here to go back and save the changes.

# 3.0 User manual

- To get back to the Home screen at any time press. 

- When entering names or values using the keyboard it is easier to use a thin object such as a toothpick. Do not use sharp, hard objects as they may damage the screen. The enter button must always be pressed to save the changes you have made. 

- Some functions may have been locked by your installer to ensure the commissioned values are not changed. To make changes to these values contact your installation company.

Tag line this will vary depending on the installation company.



# 3.1 AC unit

The screenshot shows the AC Unit Control interface. At the top, it displays the date and time: Monday 01 Jan 2011, 12:30 PM. The main title is "AC Unit Control" with a home icon. The current set point is 23.5°C. There are "Increase" and "Decrease" buttons with up and down arrow icons. Below these are "Cool" (with a snowflake icon) and "High" (with a bar chart icon) mode buttons. A "Master Control" button with a green checkmark is present. The "System Status" is currently "Normal". A "Back" button is at the bottom right. The footer reads "iZone • Inventive Intelligent • Intuitive".

Annotations with arrows pointing to the interface elements:

- Current AC unit set point. (Points to 23.5°C)
- Press here to change the mode. (Points to the Cool/High mode buttons)
- Indicates the temperature measured by this panel is currently controlling the AC unit (Only applicable if systems configured for "AC unit controlling sensor—Master" option. See 2.8). (Points to the Master Control button)
- Indicates the current status of the AC unit. If a fault code appears here please contact your installer. (Points to the Normal System Status)
- Press here to increase the AC unit set point. (Not applicable if "AC unit controlling sensor—Zones" option selected. See 2.8). (Points to the Increase button)
- Press here to decrease the AC unit set point (Not applicable if "AC unit controlling sensor—Zones" option selected. See 2.8). (Points to the Decrease button)
- Press here to change the fan speed. (Points to the High fan speed button)
- Press here to go back to the home page. (Points to the Back button)

# 3.2 Zone control

The screenshot shows the 'Zone Summary' screen for Monday 01 Jan 2011 at 12:30 PM. The screen lists several zones with their current status and temperature set points. Red arrows point from descriptive text to specific UI elements.

Zone Name	Mode/Status	Temperature
Zone 1	Climate Control (Key icon)	24.5°C
Living room	Closed (Red 'S' icon)	Closed
Dining room	Climate Control (Key icon)	23.5°C
Kitchen	Open (Green checkmark icon)	Open
Master bedroom	Climate Control (Key icon)	22.5°C
John bedroom	Climate Control (Key icon)	23.0°C
Study	Closed (Red 'S' icon)	Closed
Hall	Electronic Constant (Flag icon)	Const

Annotations:

- Indicates this zone is currently in climate control mode. (Points to Zone 1 key icon)
- Indicates Zone 1 temperature set point. Press here to change the Set point. (3.3). (Points to 24.5°C)
- Zone Name. Press to edit zone name and other zone settings (3.2). (Points to Living room)
- Indicates this zone is closed. Press here to open the zone. (Points to Living room Closed button)
- Indicates this zone is currently fully open. (Points to Kitchen green checkmark icon)
- Indicates this zone is open. Press here to close the zone. (Points to Kitchen Open button)
- Indicates this zone is currently closed. (Points to Master bedroom key icon)
- Indicates this zone is currently being overridden by the system and is being used as a constant because too many zones are closed. (Points to Hall Const button)
- Indicates the hall is an electronic constant and it is currently active. (Points to Hall flag icon)
- Press here to go back to the home page (Points to Back button)
- Scroll up or down to see more zones. (Points to Up/Down navigation buttons)

**iZone**  
Inventive · Intelligent · Intuitive

## 3.2.1 Edit zone names & settings

Monday 01 Jan 2011 12:30 PM

**Dining Room**

Current zone being edited.

System zone number and display name. **Zone 3 Dining Room**

Current zone status. **Status Climate Control**

Zone maximum and minimum air flow set points. **Max Airflow 80%**

**Min Airflow 10%**

Status of this zone if it has been selected as an electronic constant. **Constant Zone Inactive**

**10%**  
Min Airflow

Increase

Decrease

Press to edit zone name.

Press to edit current zone status.

Press to change maximum and minimum airflow set points.

Press to increase or decrease air flow set point.

Next Previous Back

**iZone**  
Inventive · Intelligent · Intuitive

# 3.2.2 Adjusting temperature controlled zones

The screenshot shows the iZone mobile application interface for a 'Dining Room' zone. At the top, it displays the date 'Monday 01 Jan 2011' and the time '12:30 PM'. The zone name 'Dining Room' is at the top left, with a home icon on the right. The current setpoint temperature is '23.5°C Setpoint'. Below this are 'Increase' and 'Decrease' buttons with up and down arrow icons. Further down are 'Open' and 'Close' buttons with their respective icons, and a 'Climate Control' button with a hand icon. At the bottom of the main control area, there are two temperature readouts: '23.5°C Actual Temp' and '22.5° In Duct Temp'. The bottom navigation bar contains 'Next', 'Previous', and 'Back' buttons. The iZone logo and tagline 'Inventive · Intelligent · Intuitive' are at the very bottom.

Indicates current zone being adjusted.

Indicates current temperature set point required for this zone.

Press here to fully open this zone.

Press here to allow iZone to automatically control the temperature in this zone.

Indicates the actual temperature in this zone (as measured by iZone).

Scroll up or down to see more zones.

Press here to increase the current zone set point temperature.

Press here to decrease the current zone set point temperature.

Press here to close this zone.

Indicates the current temperature of the air inside the air conditioning system ductwork.

Press here to go back to the zone summary.

**iZone**  
Inventive · Intelligent · Intuitive



## 3.3 Zone airflow summary

The screenshot displays the 'Zone Airflow' control interface. At the top, it shows the date 'Monday 01 Jan 2011' and the time '12:30 PM'. Below this is a blue header bar with the title 'Zone Airflow' and a home icon. The main content area lists eight zones, each with a name and two percentage settings: 'MIN' and 'MAX'. The zones and their settings are: Zone 1 (10% MIN, 80% MAX), Living room (30% MIN, 90% MAX), Dining room (10% MIN, 80% MAX), Kitchen (10% MIN, 80% MAX), Master bedroom (10% MIN, 80% MAX), John bedroom (10% MIN, 80% MAX), Study (10% MIN, 80% MAX), and Hall (10% MIN, 80% MAX). At the bottom, there are three navigation buttons: 'Up' (up arrow), 'Down' (down arrow), and 'Back' (curved arrow). The interface is branded with 'iZone Inventive · Intelligent · Intuitive' at the very bottom.

Zone Name	MIN (%)	MAX (%)
Zone 1	10%	80%
Living room	30%	90%
Dining room	10%	80%
Kitchen	10%	80%
Master bedroom	10%	80%
John bedroom	10%	80%
Study	10%	80%
Hall	10%	80%

Monday 01 Jan 2011 12:30 PM

Zone Airflow

Zone name.

Indicates current minimum air flow setting to this zone.

Indicates current maximum air flow setting to this zone.

Press here to change the zone air flow settings (3.3.1).

Scroll up or down to see more zones.

Up Down Back

**iZone**  
Inventive · Intelligent · Intuitive

## 3.3.1 Changing zone airflows

Monday 01 Jan 2011 12:30 PM

Living Room

Indicates current zone that you are changing the airflow to.

Indicates the current maximum airflow setting for this zone.

90% Max Airflow

Increase

Decrease

Press here to increase the maximum airflow to this zone.

Press here to decrease the maximum airflow to this zone.

Indicates the current minimum airflow setting for this zone. (This is usually set at 0%).

30% Min Airflow

Increase

Decrease

Press here to increase the minimum airflow to this zone.

Press here to decrease the minimum airflow to this zone.

Next Previous Back

Scroll up or down to see more zones.

Press here to go back to the airflow summary.

iZone  
Inventive · Intelligent · Intuitive

# 3.4 Favourites

Press the favourite you would like and iZone will automatically change all the zones settings for this favourite.

Indicates this favourite has not been used.

Press here to setup and edit favourites (3.2.1).

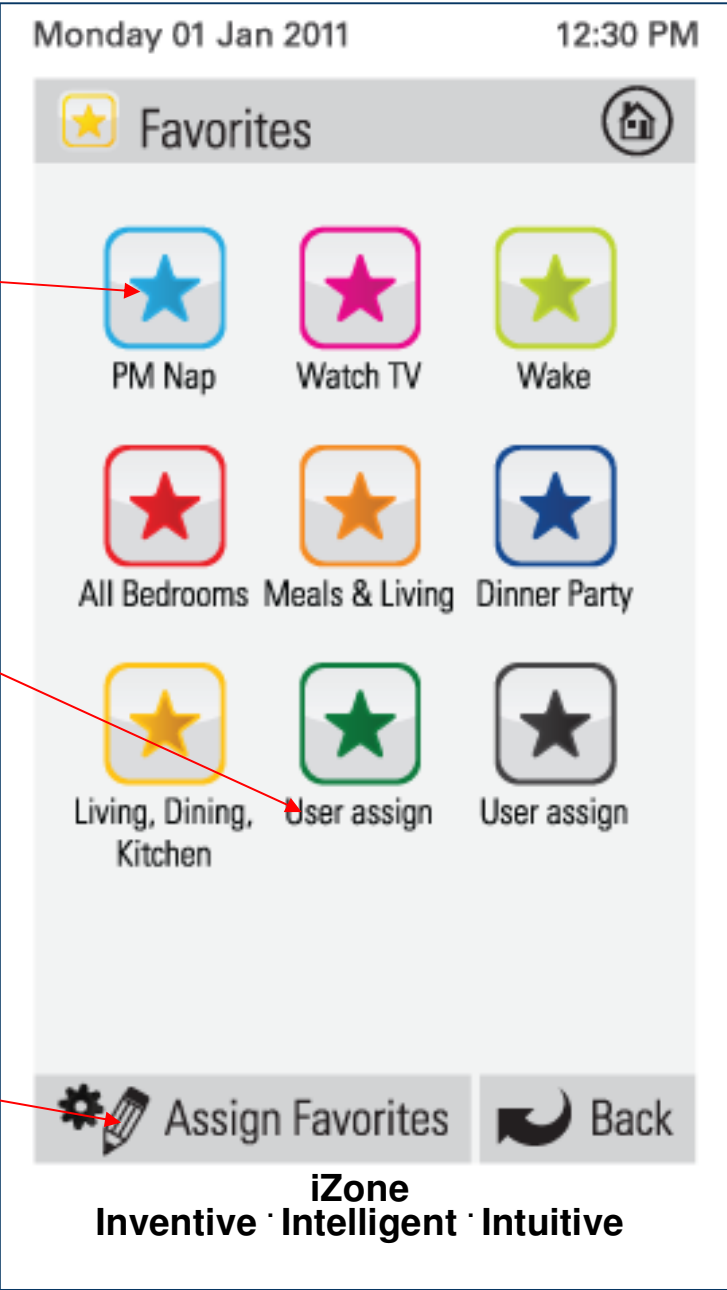











## 3.4.1 Assign and edit favourites

Monday 01 Jan 2011 12:30 PM

PM Nap 

PM Nap 

Zone 1		24.0°C
Living room		Closed
Dining room		Closed
Kitchen		Closed
Master bedroom		24.0°C
John bedroom		24.0°C
Study		Closed

 Up  Down  Back

**iZone**  
Inventive · Intelligent · Intuitive

Indicates current favourite being changed.

Zone names.

Press here to change the name of this favourite.

Indicates what mode you want each zone to operate in when this favourite is used. Change each zone setting to suit your requirements for this favourite.

Press here to go back to the favourites summary. Pressing the back button will save the favourite setting selected.

Scroll up or down to see more zones.

# 3.5 Schedules

Any of your favourites can be set to automatically start at any time of your choosing. Press here to enable the time based schedule for favourite PM Nap.

Press here to set up or edit a schedule on any favourite (3.4.1).

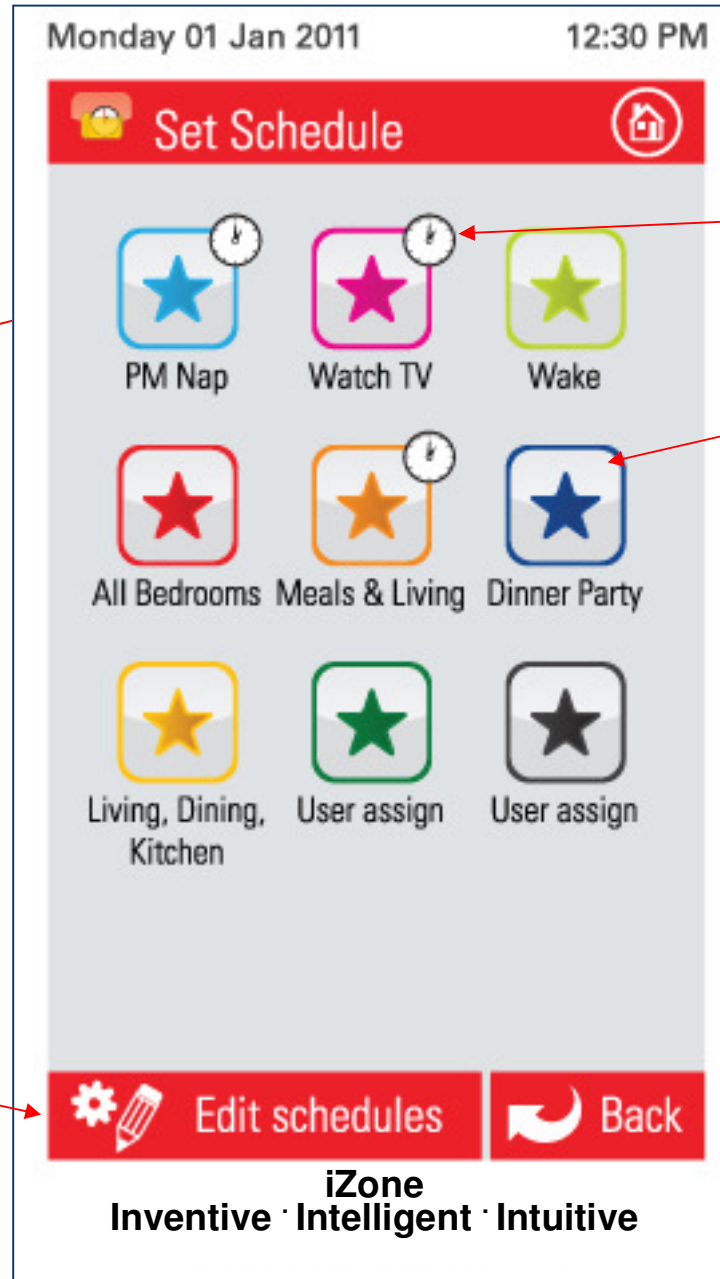

Indicates an automatic time schedule has been enabled for this favourite.

Indicates no automatic time schedule has been enabled for this favourite.

# 3.5.1 Setting and editing a schedule

Monday 01 Jan 2011 12:30 PM

**PM Nap**

24Hr Time Format

START-08:00

STOP-17:30

Mon Tue Wed Thu Fri Sat Sun

Delete this schedule

1 2 3 4 5 6 7 8 9 0

Q W E R T Y U I O P

A S D F G H J K L

Z X C V B N M , . /

Space

Next Previous Back

iZone  
Inventive · Intelligent · Intuitive

Indicates current schedule that you are changing or setting.

Indicates the start time for this schedule.

Indicates the stop time for this schedule.

Indicates the days this schedule will apply. Press to stop the schedule running on this day.

Press here to delete this schedule.

Indicates the days this schedule will not run. Press the day you want the schedule to apply to.

Press the key pad to change the time. Remember it is in 24 hour format so for 2:30 am type in 0230.

Press the enter button to save your new setting.

Press here to go back to the schedule summary.

Press next to see the next schedule.

## 3.6 Setting the time

Monday 01 Jan 2011 12:30 PM

**Set Time**

24Hr Time Format

12:30

01 / 01 / 2011  
Date / Month / Year

1 2 3 4 5 6 7 8 9 0  
Q W E R T Y U I O P  
A S D F G H J K L  
Z X C V B N M , . /  
← ↑ Space →

**Back**

**iZone**  
Inventive · Intelligent · Intuitive

Current time.

Current date.

Indicates the minutes are be changed.

Press the left or right arrows to move to the value you want to change.

You must press the enter button to save the changes you have made.

## 3.7 Changing the home screen colour

Monday 01 Jan 2011 12:30 PM

**Screen Settings**

**Screen Adjustments**

Brightness

Contrast

Saturation

**Background Select**

Back

**iZone**  
Inventive · Intelligent · Intuitive

Slide left / right to adjust the screen brightness.

Slide left / right to adjust the screen saturation.

Slide left / right to adjust the screen contrast.

Press the colour you would like for your home screen. Fine adjustments to the shade, tone, hue can be made using the brightness, contrast and saturation slides.

Press here to go back to the home screen.

The image shows a mobile phone screen with a 'Screen Settings' menu. At the top, it displays the date 'Monday 01 Jan 2011' and the time '12:30 PM'. The menu is titled 'Screen Settings' and has a home icon in the top right. Below the title is a section for 'Screen Adjustments' containing three sliders: 'Brightness', 'Contrast', and 'Saturation'. Each slider has a blue knob and is flanked by minus and plus signs. Below this is a 'Background Select' section with ten color swatches arranged in two rows of five. The colors are white, black, dark purple, light blue, red, olive green, pink, yellow, green, and light yellow. At the bottom right of the menu is a 'Back' button with a white arrow icon. At the very bottom of the screen is the 'iZone' logo and the tagline 'Inventive · Intelligent · Intuitive'. Red arrows point from text annotations to the sliders and the 'Back' button.



## 3.8 Further assistance

1. If your zone airflow adjustment or system has been locked you will need to contact your installation company to arrange for them to unlock this setting.
2. If you require warranty or maintenance on your air conditioning system or iZone system you should contact your installation company.
3. If you want to add more zones or temperature control to any zone you should contact your installation company.
4. If you require assistance operating your iZone contact:  
Airstream Components  
[www.air-stream.com.au](http://www.air-stream.com.au)  
[info@air-stream.com.au](mailto:info@air-stream.com.au)  
Phone 08 6254 2408

